



Installation and Operation Manual

NMEA 2000®

SAE J1939

SmartCraft®



PART # LIT-GA-CANB-VV-REV0617

LIVORSI
Livorsi Marine, Inc. • livorsi.com

Livorsi Marine, Inc.
715 Center Street
Grayslake, IL 60030 USA
Toll Free: 877.548.5900
Office: 847.752.2700
Fax: 847.752.2415
Email: sales@livorsi.com
www.livorsi.com

About	1
Scope	1
Preconfigured Instruments	1
Menu Navigation	2
Mode Switch	2
Up Switch	2
Down Switch	2
Switch Icon Conventions.....	2
Selection Arrow Cursor	3
Blinking Bar Cursor	4
Start-up Screen	5
Default Quick View Main Screen	5
Quick View Main Screens	5
Bar Graph & Three Line Format	6
Trips (Hours) Screen	7
Resetting Trips	7
Main Menu	8
Trips	9
View Parameters.....	10
Setup	11
Mute	12
Faults	12
Warnings.....	13
Alarms	14
Recall	15
Fuel	16
Miscellaneous	17
Restoring Factory Defaults.....	17
Setup Menu	18
Backlight	18
Units	20
Clock Viewing & Setting.....	21
Viewing & Setting	21
Clock Format	22
Main Clock.....	23
Alarms	24
Enabling Alarms.....	24
Viewing Alarms	25
Editing Alarms	26
Active & All Parameters Selection Sets.....	27
Setting Quantity of Alarms	27
Alarm Configuration.....	28
Adding Additional Alarms	30
Deleting an Alarm	31
A/D (Analog/Digital) Inputs	32
NMEA 0183 Input	32
A/D Pressure Sender Inputs.....	33
Display	35
Main Order.....	35
Main Trim	37
Trim Screen Formats.....	37
Main Clock.....	38

Main Roll.....	38
Main Recall	39
Key Off.....	40
Set Video	41
Set Contrast.....	42
Speedometer.....	43
CAN Speedometer	43
GPS (NMEA 0183) Speedometer	43
Calibration - Fuel Tank	45
Calibration Tank 1 or 2.....	46
Setting Fuel Tank Data Source	47
Setting Fuel Tank Total Capacity	48
Calibrating Fuel Tank Level.....	49
Calibrating Fuel Tank Level Step 1 - Empty Tank.....	49
Calibrating Fuel Tank Level Steps 2 thru 5	50
Resetting Fuel Tank Calibration	51
Viewing Calibration Steps	51
Viewing Calibration Steps 2 thru 5	52
Saving Fuel Tank Calibration Data.....	53
Tank Display	53
Calibration - Engine Trim.....	54
Selecting Engine Trim Sender Type for Calibration	55
Calibrating Full-Down & Full-Up Trim Sender Positions.....	56
Viewing Trim Calibration Settings.....	57
Saving Trim Calibration Settings	58
Set Popup.....	59
Trim Popup Function	60
Popup Menu	61
Enabling/Disabling Popup Features.....	61
Set CAN Bus	66
Multiple Engine Applications	67
Single Engine Applications	67
Setting SAE J1939 Engine Number.....	68
Setting SAE J1939 Default Quick View Main Screen 1 (Total Hours or Miles).....	69
Setting Master Tachometer Instance Number (SAE J1939).....	70
Setting NMEA 2000® Engine Number	71
Setting NMEA 2000® Default Quick View Main Screen 1 (Total Hours or Miles)	72
Setting Smartcraft® Engine Number.....	73
Saving Set CAN Bus Changes	74
Analog Input Parameters Table	75
Vantage View® Implementation of NMEA 2000® Parameters	76
Vantage View® Implementation of SAE J1939 Parameters	78
Vantage View® Implementation of SmartCraft® Parameters	81
SmartCraft® Engine Data Sensor List	82
Parameter Icons & Descriptions	83
Menu Navigation Icon Descriptions	86

Gauge Dimensions

• Master Tach or Speedometer- Standard Size

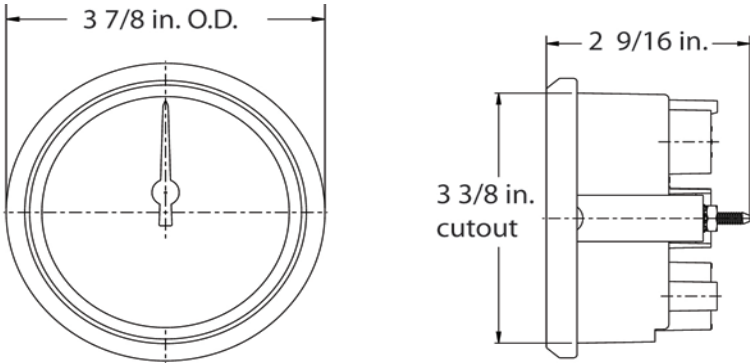

PART # LIT-GA-CANB-VV-REV0617

• Slave Gauges or FWA- Standard Size

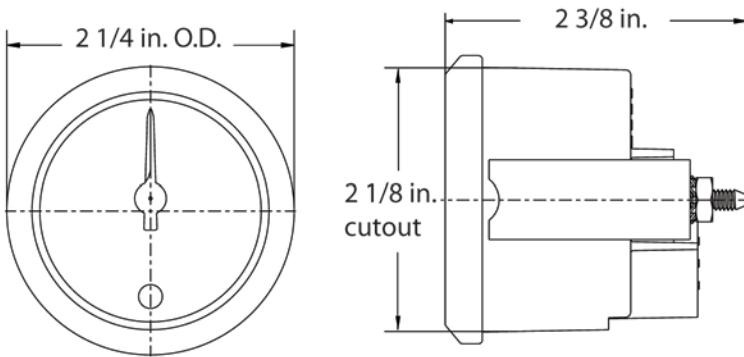

• VV Saw Assembly Switch Plate- Single Engine

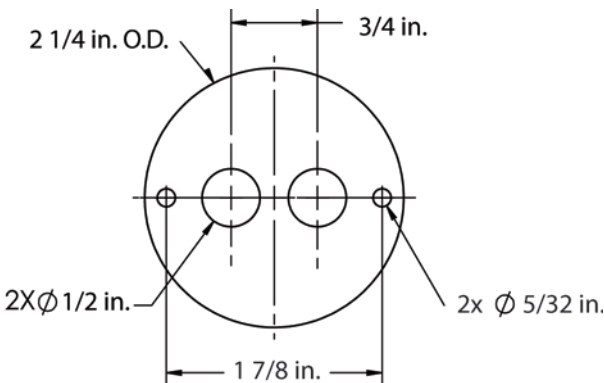

Please note: Maximum torque is 4 to 6 In lbs on all Livorsi gauge mounting hardware.

• Master Tach or Speedometer or Four Function Gauge- Over Sized

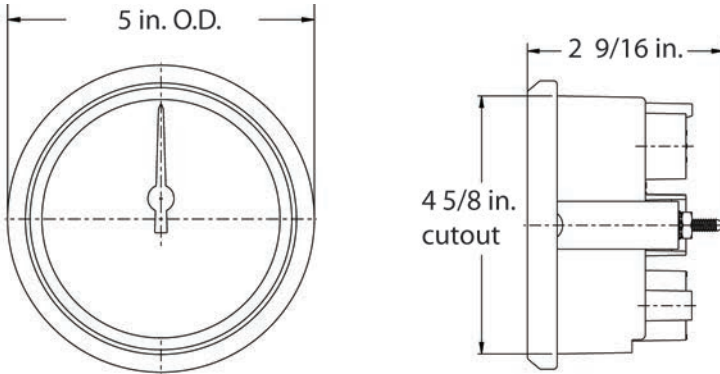

• Slave Gauges- Over Size

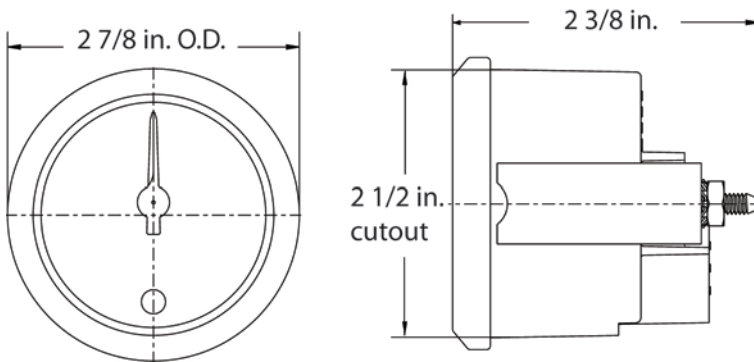

• Control Pods - Single and Multiple Engine

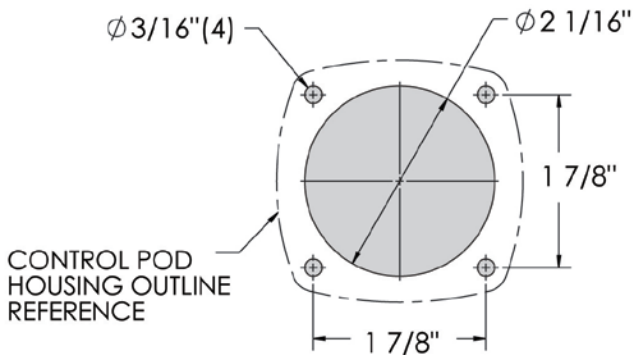

Installation Guide

IMPORTANT:

Vantage View gauge installation and gauge sequence is critical in the operation of this system. Please read the important information below before installing gauges. You cannot skip a Deutsch connector in the slave harness chain, doing so will result in network failure. The Master Tach drives all subsequent slave gauges. If there is more than one engine, each engine requires its own Master Tach, Master Harness and its own set of slave gauges (optional) for monitoring engine performance. Please follow the diagram below for proper installation.

Use the slave harness to connect the Master Tach to the slave gauges. Sequence of slave gauges is a matter of personal preference of the installer/owner with the exception of the FWA Warning gauge. (see below)

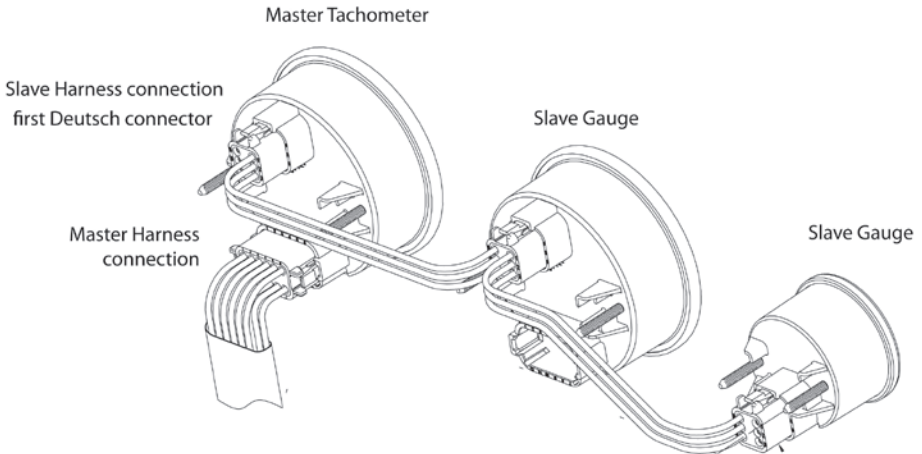

Each Master Tachometer requires its own Master Harness which connects to the network backbone.

Certain applications may require additional kits to add power drop to the backbone, if not already supplied.

Shown here: NMEA 2000 network backbone



FWA Warning Gauge Installation

The Deutsch connector to be used on this gauge has intentionally left pins 4, 5 and 6 open for an optional audible alarm. Installing this gauge on any other connector will not operate the gauge.

For detailed instructions on how to install the optional audible alarm, please see the FWA installation instructions.

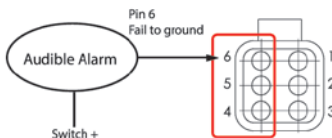

Installation Guide

• Master Harness Diagrams

SmartCraft Master Harness 36 in.
Model #: VVMHSC

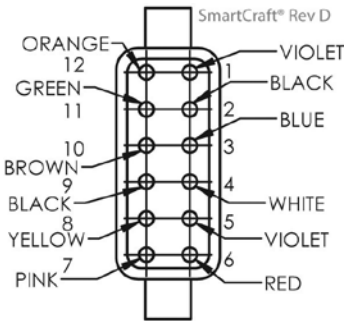

Wire Labeling/Color chart		REV D
#	COLOR	LABEL
7	PINK	ANALOG
8	YELLOW	NMEA 0183
9-12		TO AMP CONNECTOR

NMEA 2000® Micro C Male Master Harness - 36 in.
Model #: VVMHN2K

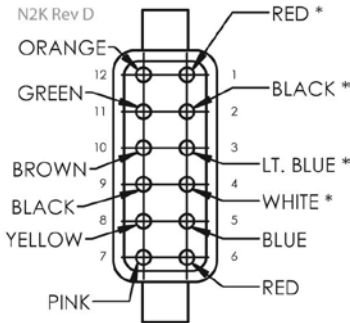

Wire Labeling/Color chart		REV D
#	COLOR	LABEL
5	BLUE	LIGHTING
6	RED	BATTERY
7	PINK	ANALOG
8	YELLOW	NMEA 0183
9-12		TO AMP CONNECTOR

NMEA 2000® Micro C Female Master Harness - 36 in.
Model #: VVMHN2KF

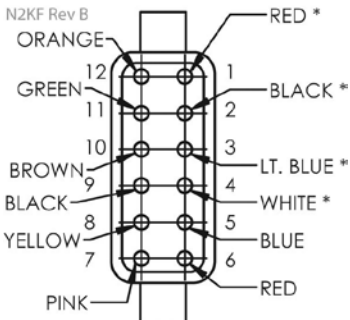

Wire Labeling/Color chart		REV B
#	COLOR	LABEL
5	BLUE	LIGHTING
6	RED	BATTERY
7	PINK	ANALOG
8	YELLOW	NMEA 0183
9-12		TO AMP CONNECTOR

Installation Guide

• Master Harness Diagrams

SAE J1939 Master Harness - 36 in.
Model #: VVMHJI

HJI REV F

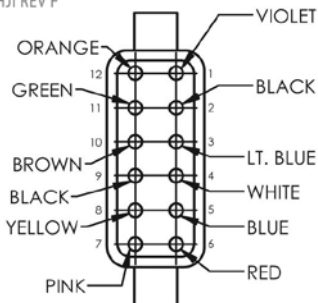

Ilmor Micro C Male Master Harness - 36 in.
Model #: VVMHIL

HIL Rev C

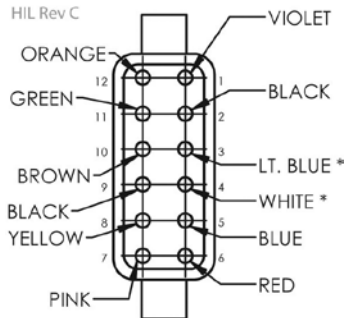

Wire Labeling/Color chart		REV F
#	COLOR	LABEL
1	VIOLET	SWITCHED POWER
2	BLACK	GROUND
3	LT. BLUE	CAN L
4	WHITE	CAN H
5	BLUE	LIGHTING
6	RED	BATTERY
7	PINK	ANALOG
8	YELLOW	NMEA 0183
9-12		TO AMP CONNECTOR

Wire Labeling/Color chart		REV C
#	COLOR	LABEL
1	VIOLET	SWITCHED POWER
2	BLACK	GROUND
5	BLUE	LIGHTING
6	RED	BATTERY
7	PINK	ANALOG
8	YELLOW	NMEA 0183
9-12		TO AMP CONNECTOR

• Slave Harness Diagrams

• Short Slave Harness

Description	Model #
2 gauge harness	VVSH2S
4 gauge harness	VVSH4S
6 gauge harness	VVSH6S

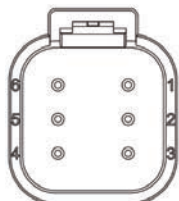

Long Slave Harness

Description	Model #
2 gauge harness	VVSH2L
4 gauge harness	VVSH4L
6 gauge harness	VVSH6L

Slave Harness Connections

Pin Number	Label
1 & 6	Battery/Power +
2 & 5	Ground
3 & 4	Serial Data

Installation Guide

• Control Pod Wiring

Both the Master Harness and the control pod are supplied with amp connectors to facilitate installation. Simply join the two connectors. Please note that if using the VVSAW assembly, it will connect to the Master Harness in the same manner.

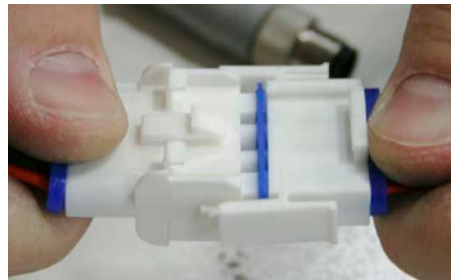
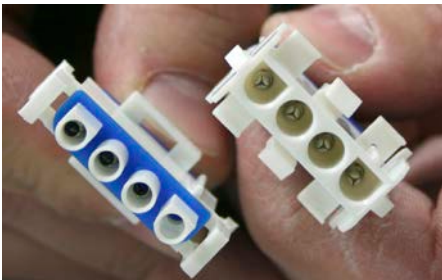
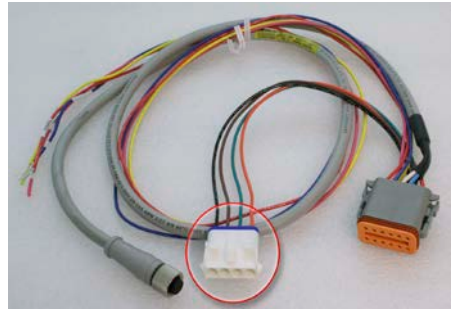

Make sure clips are properly secured.

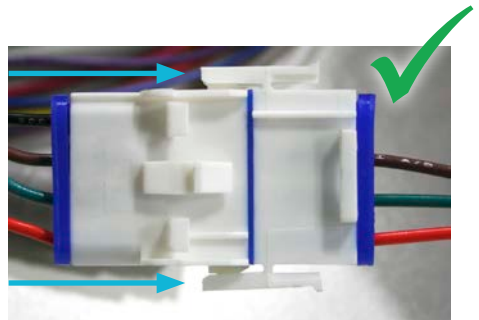
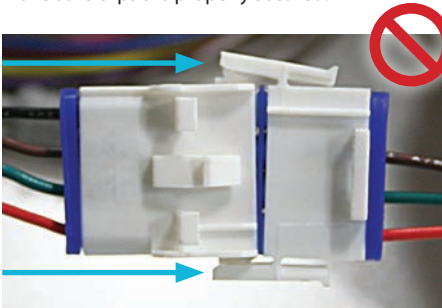

Installation Guide

• Fuel Sender Compatibility

Float Arm and Fuel/Water Level Senders are compatible with the Vantage View system. As well as 3 terminal senders.

240-33ohms / 10-180ohms / 0-90ohms /Centroid 3

• GPS Receiver/Antenna

GPS Speed requires the use of a NMEA 0183 GPS receiver/antenna. It is recommended to use Livorsi part number GPSRAQ3VV as power and ground are pre-terminated and the signal wire is pre-terminated with a butt connector to connect to the NMEA 0183 input on the Master Harness.



Antenna Wire Connections	
White	Signal NMEA 0183 output, pre-terminated with butt connector
Red	Switched 12V power
Black	Ground

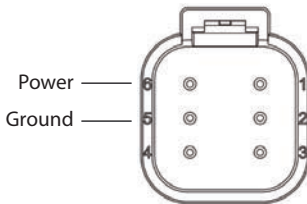

Antenna Connections to Slave Harness	
Pin Number	Label
1 & 6	Battery/Power +
2 & 5	Ground
3 & 4	Serial Data



Connection to NMEA 0183 Input from Master Harness

List of Figures

Figure 1-1: Menu Scrolling and Option Selection	3
Figure 1-2: Blinking Bar Cursor	4
Figure 1-3: Quick View Main Screens	5
Figure 1-4: Setting Parameter View Display Format	6
Figure 1-5: Resetting Trip (Hour) Logs	7
Figure 1-6: Accessing the Main Menu	8
Figure 1-7: Accessing Trip Logs from the Main Menu	9
Figure 1-8: Viewing Parameters	10
Figure 1-9: Accessing the Setup Menu	11
Figure 1-10: Fault Notification & Information Screens	12
Figure 1-11: Quick View Main Screen with Warning "W" Icon	13
Figure 1-12: Warning Notification and Information Screens	13
Figure 1-13: Quick View Main Screen with Alarm "Bell" Icon	14
Figure 1-14: Recall Function	15
Figure 1-15: Fuel Management Function	16
Figure 1-16: Miscellaneous Functions Menu	17
Figure 1-17: Setup Menu Functions	18
Figure 1-18: Setting Backlight Intensity	19
Figure 1-19: Setting Units	20
Figure 1-20: Clock Viewing and Time/Date Setting	21
Figure 1-21: Setting Clock Format and Displaying Date	22
Figure 1-22: Enable Display of Main Clock	23
Figure 1-23: Enabling/Disabling Alarms	24
Figure 1-24: Viewing Alarms	25
Figure 1-25: Edit Alarms Function	26
Figure 1-26: Selecting Active or All Parameters	27
Figure 1-27: Selecting Alarm Quantity	27
Figure 1-28: Analog Parameter Alarm Configuration Screen Detail	28
Figure 1-29: CAN Parameter Alarm Configuration Screen Detail	28
Figure 1-30: Alarm Configuration	29
Figure 1-31: Adding Additional Alarms	30
Figure 1-32: Deleting Alarm(s)	31
Figure 1-33: Connector Analog Input Pins	32
Figure 1-34: A/D Input Setup	33
Figure 1-35: A/D Pressure Sender Input Configuration	34
Figure 1-36: Display Menu	35
Figure 1-37: Quick View Main Screen Parameter Selection	36
Figure 1-38: Adding Trim Parameters to Quick View Main Screen Display List	37
Figure 1-39: Trim Screen Formats	37
Figure 1-40: Adding Clock Display to Quick View Main Screen List	38
Figure 1-41: Quick View Main Screen Scrolling Style	38
Figure 1-42: Setting Quick View Main Screen Scrolling Style	39
Figure 1-43: Setting Quick View Main Screen Recall	39
Figure 1-44: Setting Key Off Display Options	40

List of Figures

Figure 1-45: Setting LCD Background Color Scheme	41
Figure 1-46: Setting LCD Contrast	42
Figure 1-47: Setting Speedometer Source	43
Figure 1-48: Calibration Menu	45
Figure 1-49: Selecting a Fuel Tank to Configure.	46
Figure 1-50: Selecting Fuel Tank Data Source	47
Figure 1-51: Setting Fuel Tank Capacity.	48
Figure 1-52: Setting Empty Tank Calibration Point	49
Figure 1-53: Setting Tank Calibration Points for 25-100%	50
Figure 1-54: Resetting Fuel Tank Calibration Data Points	51
Figure 1-55: Viewing Fuel Tank Calibration Step 1	51
Figure 1-56: Viewing Fuel Tank Calibration Steps 2 thru 5	52
Figure 1-57: Saving Fuel Tank Data & Calibration Steps	53
Figure 1-58: Engine Trim Calibration Menu	54
Figure 1-59: Engine Trim Calibration Menu	55
Figure 1-60: Setting Full-Down Trim Position	56
Figure 1-61: Setting Full Up Trim Position	57
Figure 1-62: Viewing Engine Trim Settings	57
Figure 1-63: Saving Engine Trim Settings	58
Figure 1-64: Popup Fault, Warning & Alarm Screens	59
Figure 1-65: Acknowledging Fault, Warning or Alarm Notification	59
Figure 1-66: Popup Engine/Tab Trim Screen	60
Figure 1-67: Popup Menu	61
Figure 1-68: Setting Trim Popup State	62
Figure 1-69: Setting Fault Popup State	63
Figure 1-70: Setting Warning Popup State	63
Figure 1-71: Setting Alarm Popup State	64
Figure 1-72: Enable All Popup Functions	64
Figure 1-73: Disable All Popup Functions	65
Figure 1-74: Setting CAN Bus Protocol	66
Figure 1-75: Engine Sync No Data Message	67
Figure 1-76: Setting SAE J1939 Engine Number	68
Figure 1-77: Setting SAE J1939 Default Quick View Main Screen 1	69
Figure 1-78: Setting Master Tach Instrument Instance Number	70
Figure 1-79: Setting NMEA 2000® Engine Number	71
Figure 1-80: Setting NMEA 2000 Default Quick View Main Screen 1	72
Figure 1-81: Setting SmartCraft® Engine Number	73
Figure 1-82: Saving Set CAN Bus Changes	74

• About

Vantage View® is the next generation instrumentation system from Livorsi that combines the best of analog and digital data display technologies.

Vantage View® reads and displays vehicle performance data directly from CAN (Controller Area Network) equipped apparatus that support protocols such as SAE J1939, NMEA 2000® or SmartCraft®, and supports a maximum of three analog sender inputs. The system consists of a Master Tach instrument and optional complementary slave instruments. This system eliminates the need for a translation “black box” between an ECM/ECU and the instruments themselves making wiring and installation simple and fast.

• Scope

This manual describes how to navigate the LCD interface and use the many features found in a Vantage View® Master Tach Instrument. Although the interface is intuitive and easy to navigate, this operation manual provides users with a resource to realize the full potential and capabilities of Vantage View® instrumentation. Covered in this manual are display options, menu navigation and menu function usage.

Although some wiring connections are noted for easy reference, this manual does not cover complete installation mounting and wiring requirements. Please refer to the Vantage View® installation instruction sheet for proper installation.

• Preconfigured Instruments

Some instruments are preconfigured at the factory to individual OEM specifications to best meet the need of the application and end user. Preconfigured features include but may not be limited to the type and quantity of Quick View Main Screens, alarm configuration(s) and active CAN protocol. Preconfigured features are easily modified to satisfy personal preferences.

• Menu Navigation

Menu navigation requires the use of three externally mounted momentary switches connected to the Master Tach instrument. The switch functions are MODE, UP and DOWN. These switches are supplied and installed by the vehicle/equipment manufacturer.

• Mode Switch- Menu/Enter/Reset

As its name suggests, this switch serves several purposes when navigating the Vantage View® user interface. The function depends upon the context of the menu.

Menu Function: Pressing and holding this switch for approximately three seconds while any of the Quick View Main Screens are displayed brings up the Main Menu.

Mode Function: Pressing and releasing this switch while any of the Quick View Main Screens are displayed toggles the display mode between three-line and detailed bar graph formats.

Enter Function: Pressing and releasing this switch provides enter functionality when Vantage View® requires you to choose a menu item, parameter selection or value input.

Reset Function: Pressing and holding this switch resets trip miles and maintenance hour values to zero when either of those screens are displayed.

• Up Switch

Pressing and releasing the Up switch scrolls up through parameter lists and menu choices or increases a value one item/unit at a time.

Pressing and holding the Up switch continuously scrolls up through parameter lists, menu choices or increases a value until the end of the parameter list, menu choices or maximum parameter value is reached.

• Down Switch

The Down switch functions identical to the Up switch with the exception that its direction for all displays, menu choices and values is down or decreasing.

• Switch Icon Conventions

Throughout this manual icons are used to indicate actions required by the user to navigate the menus. Below are descriptions and the corresponding action to be taken when they appear.



Press and release Mode switch icon.

The presence of this icon in the manual indicates when to press and release the Mode switch.



Press and hold Mode switch icon.

The presence of this icon in the manual indicates when to press and hold the Mode switch for approximately three seconds.



Press Up switch icon.

The presence of this icon in the manual indicates when to press and release the Up switch. Users may also choose to press and hold the Up switch if necessary.



Press Down switch icon.

The presence of this icon in the manual indicates when to press and release the Down switch. Users may also choose to press and hold the Down switch if necessary.

• Menu Navigation (Continued)

Vantage View® uses various icons and indicators to guide users for item selection and/or input while navigating the menus. The selection arrow and blinking bar cursors appear frequently throughout the menus.

• Selection Arrow Cursor



The selection arrow cursor, shown at left, identifies adjacent menu items as the current selection. Pressing the Mode switch selects the menu item/function or value adjacent to the arrow cursor.

Pressing and releasing an Up or Down switch moves the selection arrow up or down a menu list one item at a time until the beginning or end of the list is reached. Pressing and holding the Up or Down switch continuously moves the selection arrow up and down a menu list until the switch is released or the beginning or end of the list is reached.

Figure 1-1: Menu Scrolling and Option Selection

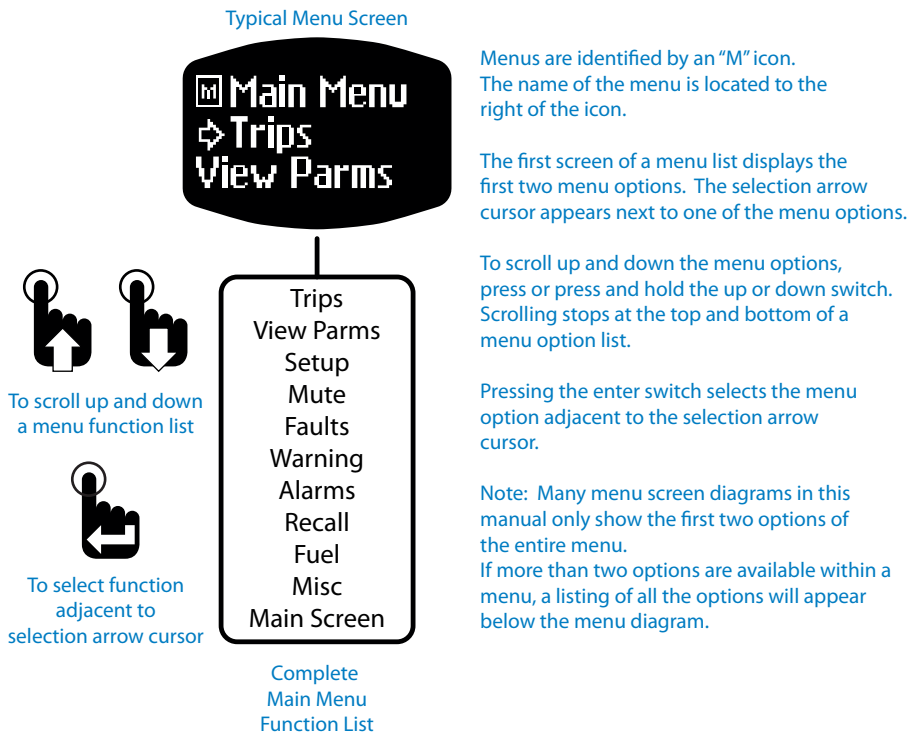

Blinking Bar Cursor

A blinking bar cursor appearing beneath a numeric value or parameter indicates the item may be changed by pressing or pressing and holding the Up or Down switches.

When a numeric value appears above a blinking bar cursor, pressing or pressing and holding the Up or Down switch increases or decreases the value until the maximum value limits are reached.

When a parameter or parameter option appears above a blinking bar cursor, pressing or pressing and holding the Up or Down switch scrolls through the list of parameters or parameter options until the end of the list is reached.

Figure 1-2: Blinking Bar Cursor

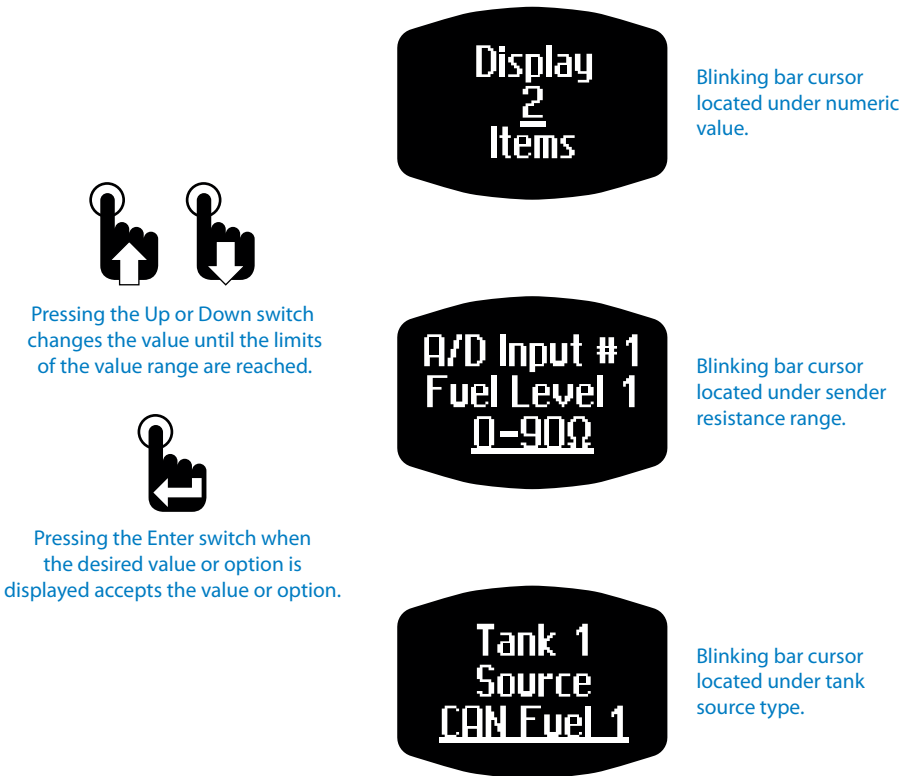

• Start-up Screen

Upon Instrument start-up the Livorsi logo and/or one of several possible CAN based protocol logo(s) appear for approximately three seconds.

• Default Quick View Main Screen

The default Quick View Main Screen screen appears after completion of the start-up routine and replaces the start-up logo. For marine applications, the first Quick View Main Screen display is factory set to show total hours and always appears as the first screen in the list of parameters/functions set for Quick View Main Screen display.

• Quick View Main Screens

Quick View Main Screens allow for easy viewing of up to 12 commonly used vehicle operating parameters or functions by pressing the Up and Down switches. Users choose the quantity, order and type of parameters to include in the Quick View Main Screen list.

Quick View Main Screens are often factory configured to OEM requirements but are easily reconfigured to meet individual user preferences.

The first screen in the list of Quick View Main Screens is permanently set to total hours for marine applications. The total hours screen may not be removed from or reordered in the screen list.

The trim (engine and/or tab) screen along with the time/date screen always appears last in the screen display stack with trim appearing before time/date if both are enabled for display.

See "Display" on page 35 for configuring Quick View Main Screens.

Figure 1-3: Quick View Main Screens

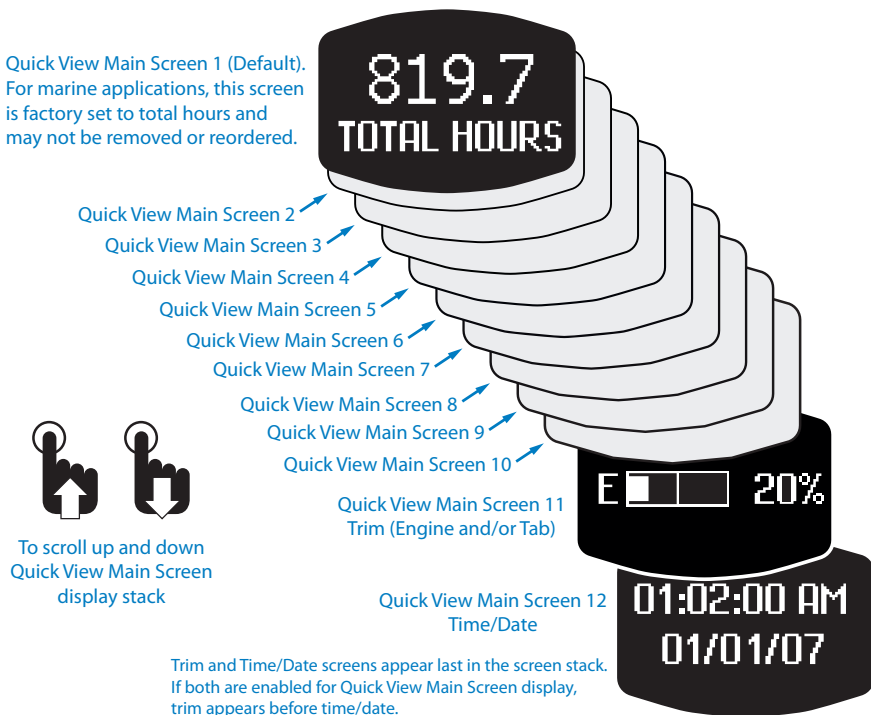

• Bar Graph & Three Line Format

Vantage View® can display vehicle operating parameters on the Quick View Main Screens in two formats, single parameter bar graph or three-line. The default display format is single parameter bar graph which provides the most detail for a given parameter. The three-line display allows users to view three parameters concurrently but with less detail. Total Hours, Total Miles and Engine Trim are not displayed in the three-line format.

Pressing and releasing the Mode switch while any Quick View Main Screen except Total Hours, Total Miles, Main Clock or Main Trim is active toggles between single parameter bar graph and three-line display formats.

When using the three-line format, if more than three parameters are configured for Quick View Main Screen display, use the Up and Down switches to scroll through the display stack. If fewer than three parameters are configured for viewing then less than three parameters appear with the three-line format active.

Figure 1-4: Setting Parameter View Display Format



Quick View Main Screen 1

Note: Total Hours, Total Miles, Main Clock and Main Engine Trim parameters do not display in three-line format.

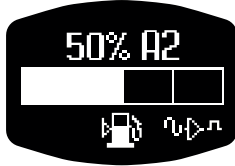

Quick View Main Screen 2 appears in single function bar graph format (default setting).



Three-line display format appears.

Note: If less than three parameters are configured for Quick View Main Screen display, fewer than three lines appear.

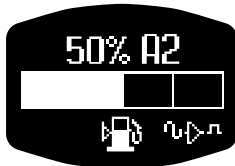

Pressing the Enter switch again toggles back to single function bar graph format.

• Trips (Hours) Screen

Vantage View® offers three maintenance hour logs or trips. To access the trips screen press and release the Mode switch when the total hours Quick View Main Screen is active. Pressing the Mode switch a second time returns the total hours screen.

The trips screen is also accessed by selecting *Main Menu - Trips*. See "Trips" on page 9.

• Resetting Trips

To reset any of the three maintenance hour logs to zero, position the selection arrow cursor next to the trip hour log to be reset by using the Up or Down switch.

Once the selection arrow cursor is next to the log to reset, press and hold the Mode (Reset) switch until the value changes to zero.

Figure 1-5: Resetting Trip (Hour) Logs

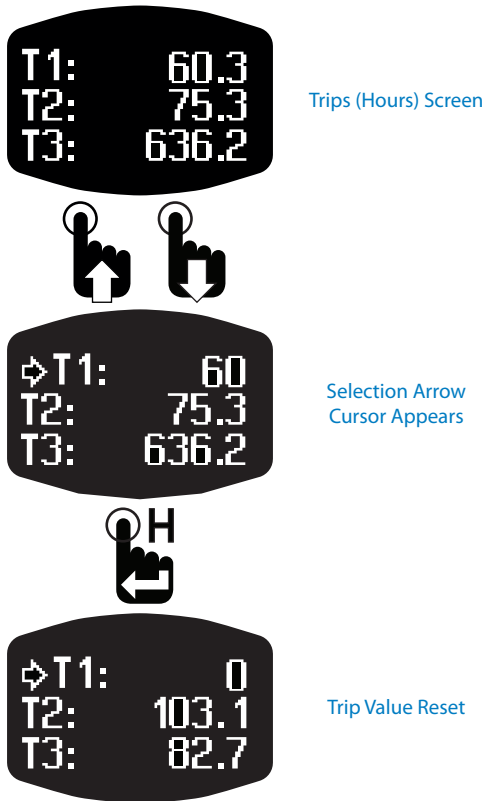

• Main Menu

The Main Menu contains functions to configure the LCD (Liquid Crystal Display), set alarms or view ECM faults and warnings. Some frequently used Setup Menu functions are also located in the Main Menu to provide easier and faster access.

Access the Main Menu by pressing and holding the Menu switch while any Quick View Main Screen is active.

Like all Vantage View® menus with multiple functions, only the first two Main Menu options appear on the screen below the menu name. Access the other options by scrolling down the menu list using the Down switch. Use the Up switch to scroll back up the Main Menu function list.

The Main Menu and all the functions within it except View Parameters will display for approximately 30 seconds if no user activity is detected. The first (Default) Quick View Main Screen appears after 30 seconds of inactivity.

Figure 1-6: Accessing the Main Menu

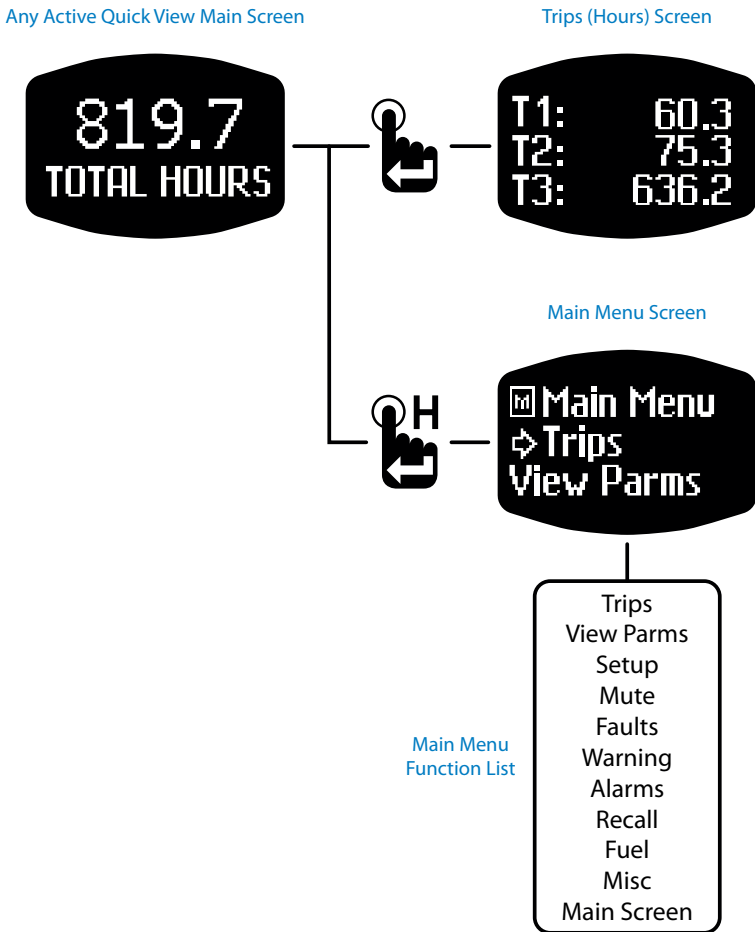

• Trips

Selecting the trips function in the Main Menu displays three separate maintenance hour logs. This is an alternate method to pressing the Mode switch with any Quick View Main Screen active.

Resetting any of the three maintenance hour logs is described below and previously on page 7. The only difference from this method to the previously described method is the trips log is accessed using the Main Menu function Trips instead of pressing the Mode switch while a Quick View Main Screen is displayed.

Figure 1-7: Accessing Trip Logs from the Main Menu

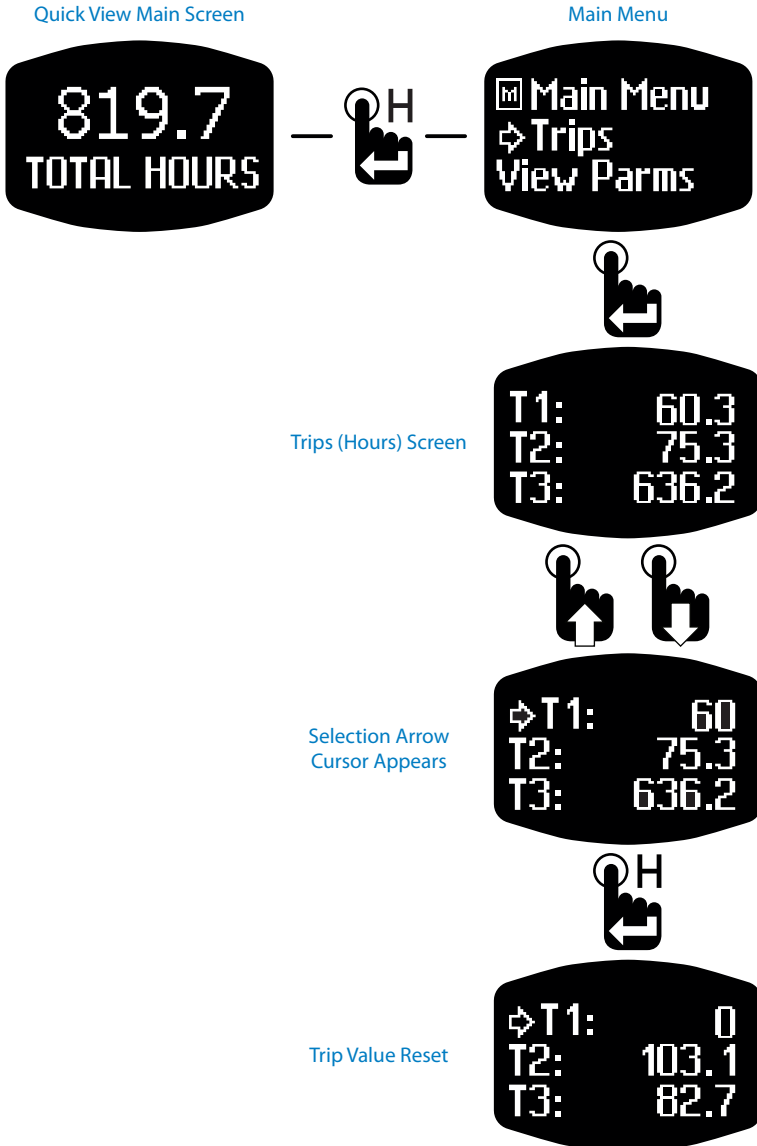

• View Parameters

View Parms is an abbreviation for viewing actively broadcast parameters and inputs. Parameter sources include analog inputs, NMEA 0183 input and CAN protocols. The quantity and type of parameters depends upon the CAN protocol used along with the configuration of analog inputs.

Parameters are displayed in single function bar graph format when viewed using View Parms. Use the Up and Down switches to scroll through the list of parameters. Analog input parameters display before CAN parameters. If the Master Tach Instrument is configured with an NMEA 0183 input, the parameter will display last in the parameter viewing list. If the NMEA 0183 feature is available and not used, the display will indicate "Missing NMEA 0183 Data".

Unlike other Main Menu functions, the parameter display will not time-out after 30 seconds. Press the Mode switch to exit viewing parameters and display the first (Default) Quick View Main Screen.

Figure 1-8: Viewing Parameters



Select View Parms from the Main Menu, *Main Menu-View Parms*, then press the Enter switch to accept.



First actively broadcast parameter appears. Coolant temperature shown as an example only.

Use the Up and Down switches to scroll through the list of broadcast parameters. Parameter display will not time out.



Pressing the Mode switch returns the first Quick View Main Screen.

• Setup

The Setup option in the Main Menu provides the functions necessary for configuring Vantage View® to suit individual preferences or application requirements. Such functions range from backlight intensity to choosing and setting alarms. See page 18 for Setup Menu function descriptions.

Figure 1-9: Accessing the Setup Menu



Access the Main Menu by pressing and holding the Menu Switch. Scroll down to the Setup option using the Down switch.

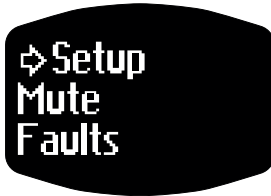

Second Main Menu screen appears with selection arrow cursor adjacent to the Setup option.



Setup Menu first screen appears showing first two setup functions. Use the Up and Down switches to scroll through the menu functions.

- Backlight
- Units
- Clock
- Alarms
- A/D Inputs
- Display
- Speedometer
- Calibration
- Set Popup
- Set CAN Bus
- Return
- Main Screen

Setup Menu Function List (Standard)

Note: Since instruments are often factory configured to OEM specifications, some Setup Menu functions in the list may not appear on your instrument.

• Mute

When a Vantage View® Master Tach Instrument is connected to a FWA (Fault, Warning & Alarm) Slave Instrument with audible output capabilities, the mute function temporarily turns off the audible alarm.

Faults are muted for 20 seconds. Warnings and alarms are muted for 2 minutes. Faults are muted for a shorter period of time because they are considered critical conditions that require immediate attention. A fault condition sounds a steady audible tone while warnings and alarms sound an intermittent tone.

• Faults

Faults are an indicator of a severe vehicle problem as reported by the ECM/ECU that warrants stopping the engine/vehicle/vessel. Users should consult the owners manual or a service technician to correct the fault condition(s).

When a fault condition occurs, a blinking "F" icon appears at the bottom of the current Quick View Main Screen.

The *Main Menu-Faults* option allows users to view the parameter or parameters causing the fault. If popups for fault conditions is enabled, a fault notification screen appears. Refer to "Set Popup" on page 59.

Figure 1-10: Fault Notification & Information Screens

NMEA 2000® Fault Screen

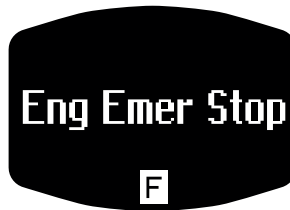

SAE J1939 Fault Screen



Fault Notification Screen Appears if Popups are Enabled.
Refer to Setting Popups.

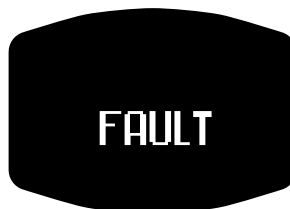

Select Faults option from the Main Menu to display active warnings.

• Warnings

Warnings are an indicator of vehicle problem as reported by the ECM/ECU that does not warrant immediately stopping the vehicle or vessel. Users should consult the owners manual or a service technician to correct the warning condition(s).

When a warning condition occurs a blinking "W" icon appears at the bottom of the current Quick View Main Screen.

Figure 1-11: Quick View Main Screen with Warning "W" Icon



The Main Menu Warnings option allows users to view the parameter(s) causing the warning. If popups for warning conditions is enabled, a warning notification screen appears. Refer to "Set Popup" on page 59.

Figure 1-12: Warning Notification and Information Screens

Warning List Screen
Showing Two Active Warnings



Select Warnings option from the Main Menu to display active warnings.

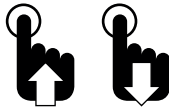

To scroll up and down the warning list when more than three occur.

Fault Notification Screen
Appears if Popups are Enabled.
Refer to Setting Popups.



• Alarms

Alarms are user configured limits for CAN or analog parameters used to alert operators when the parameter or parameters exceed those limits. Alarms help users protect a vehicle, vessel or equipment from damage by providing an option to set operating notification limits for parameters critical to the application.

The *Main Menu-Alarms* function allows users to view the parameter causing the alarm as well as provides all the functions necessary to configure alarms. The alarm function is also located in the Setup Menu. Refer to *Main Menu - Setup - Alarms* on page 24 for detailed descriptions of all the Alarm Menu features.

Note: Alarms are only a notification feature and does not disable or diminish the operation of a vehicle or equipment.

Vantage View® allows users to set up to 15 parameters for alarm notification.

Alarm settings are written to non-volatile memory and retained when power is removed from the instrument.

Once a parameter exceeds the set operating limits, a blinking "Bell" icon appears at the bottom of the current Quick View Main Screen.

Figure 1-13: Quick View Main Screen with Alarm "Bell" Icon



• Recall

The recall function displays the maximum vehicle speed and engine RPM. The recall data is stored in non-volatile memory which retains the information until it is reset or overwritten by higher values.

To reset either recall value to zero, place the selection arrow cursor at the value to reset by using the Up and Down switches. Once the cursor is adjacent to the desired value, press and hold the Mode switch until the value changes to zero.

Figure 1-14: Recall Function

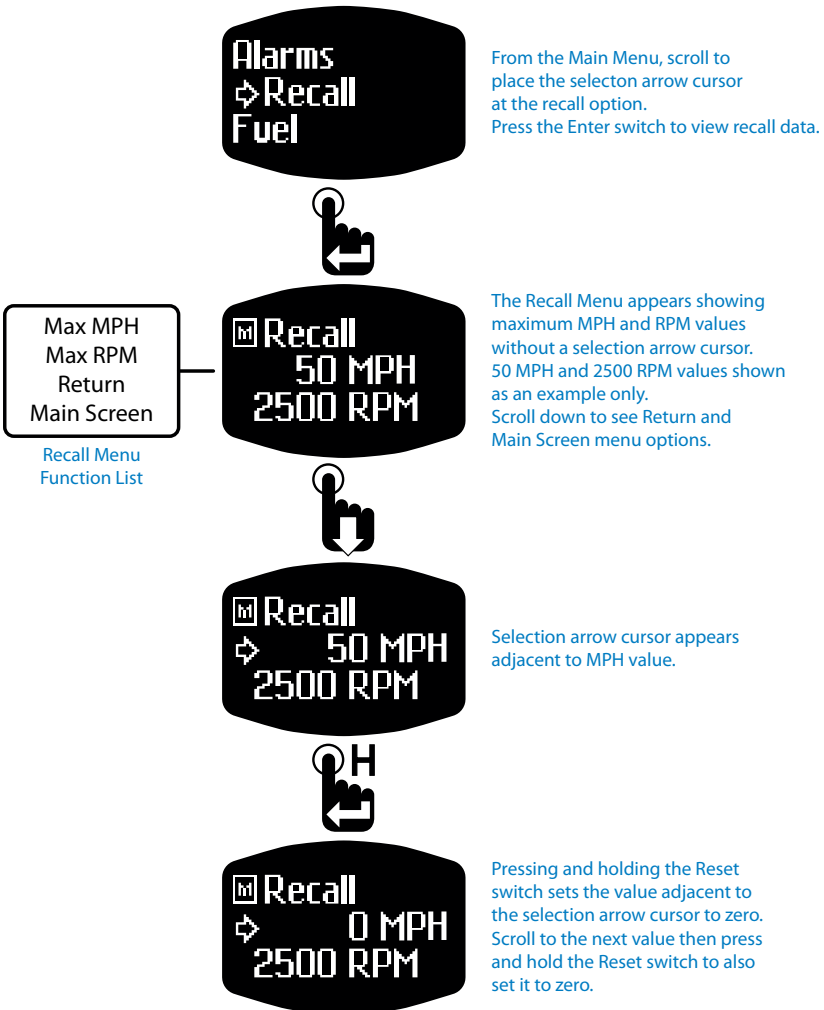

• Fuel

The fuel Main Menu function provides fuel management data such as consumption rate, amount remaining and amount used.

In order to see and use all the fuel management features, fuel tanks must be calibrated using *Main Menu-Setup-Calibration* function found on page 45.

If the fuel tank(s) are not calibrated using the calibration setup routine, only the fuel rate option appears.

In order to display fuel rate data, the engine/vehicle/vessel must be equipped with a fuel flow sensor.

Figure 1-15: Fuel Management Function

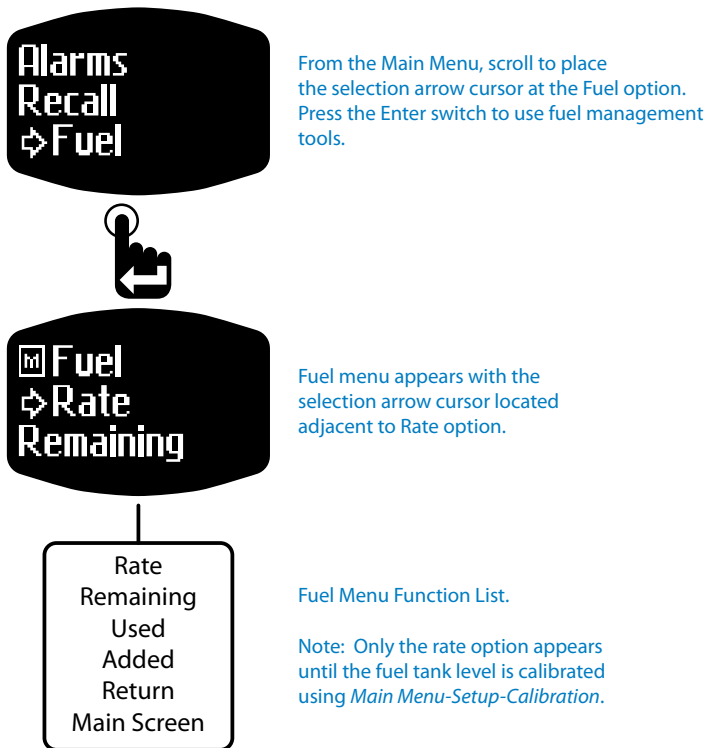

Fuel Menu function summary:

Rate - Displays fuel consumption in GPH, gallons per hour. Requires fuel flow sensor.

Used - Displays amount of fuel consumed.

Added - Tells Vantage View® fuel was added to the tank so fuel management is recalculated.

Return - Brings users back to Fuel option in Setup Menu.

Main Screen - Brings users back to the default Quick View Main Screen.

• Miscellaneous

The Miscellaneous Menu contains functions for restoring factory default settings, viewing current firmware revision and active CAN Bus protocol.

Figure 1-16: Miscellaneous Functions Menu

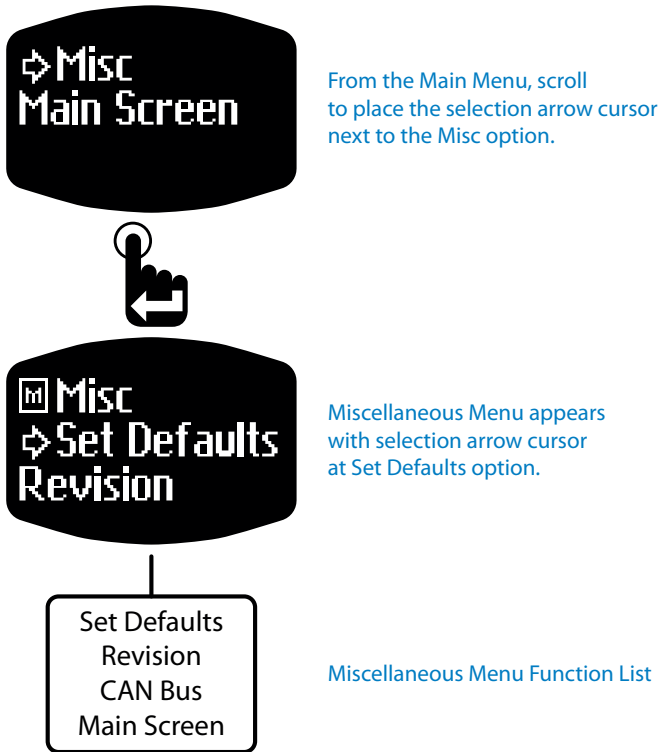

Miscellaneous Menu Function summary:

- Set Defaults - Restores all factory settings.
- Revision - Displays Vantage View® firmware revision.
- CAN Bus - Displays current CAN protocol.
- Main Screen - Brings users back to the default Quick View Main Screen.

• Restoring Factory Defaults

The *Main Menu-Misc-Set Defaults* function restores a Master Tach Instrument to its factory configured settings.

This function removes all user set Quick View Main Screen display parameters, alarms, A/D Inputs and all modified display and operating settings.

Users should note all custom settings, alarms, etc prior to restoring factory defaults to make it easier to reconfigure any or all of those settings.

• Setup Menu

The Setup Menu contains all the functions necessary to configure a Master Tach Instrument to satisfy user preferences and application requirements. This section of the manual describes those functions.

Figure 1-17: Setup Menu Functions

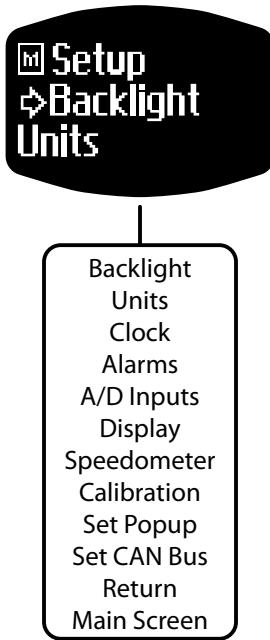

To access the Setup Menu, *Main Menu-Setup*, press and hold the Menu Switch with any Quick View Main Screen displayed until the Main Menu appears.

Scroll to the Setup option using the Down Switch then press the Enter switch.

Setup Menu Function List (Standard)

Note: Since instruments are often factory configured to OEM specifications, some Setup Menu functions in the list may not appear.

Setup Menu function summary:

Backlight - Sets intensity of instrument illumination.

Units - Sets display units to English or SI-Metric.

Clock - For enabling/disabling clock display, setting time and clock display format.

Alarms - For enabling/disabling, viewing and creating/editing parameter alarm notification.

A/D Inputs - For configuring analog and NMEA inputs to a Master Tach Instrument.

Display - Use to add/delete Quick View Main Screens, set LCD key-off display, positive or negative image mode and adjust LCD contrast.

Speedometer - Use to set speedometer type, CAN or GPS

Calibration - Characterizes fuel senders to fuel tanks and trim senders to actual trim position.

Set Popup - Activates notification screen for faults, warnings and alarms.

Set CAN Bus - Sets the CAN protocol a Master Tach Instrument will read.

Return - Brings users back to *Main Menu-Setup*.

Main Screen - Brings users back to the default Quick View Main Screen.

• Backlight

Backlight intensity is set using the Backlight option from the Setup Menu.

Users can set backlight intensity for when the vehicle lamp switch is on (Lamp On option) or when the vehicle lamp switch is off (Lamp Off) option.

The lamp off option allows users to turn on the instruments backlighting independent of the vehicles light switch.

Backlight intensity values range from 0 (off) to 100 (Max) by increments of 10.

Figure 1-18: Setting Backlight Intensity

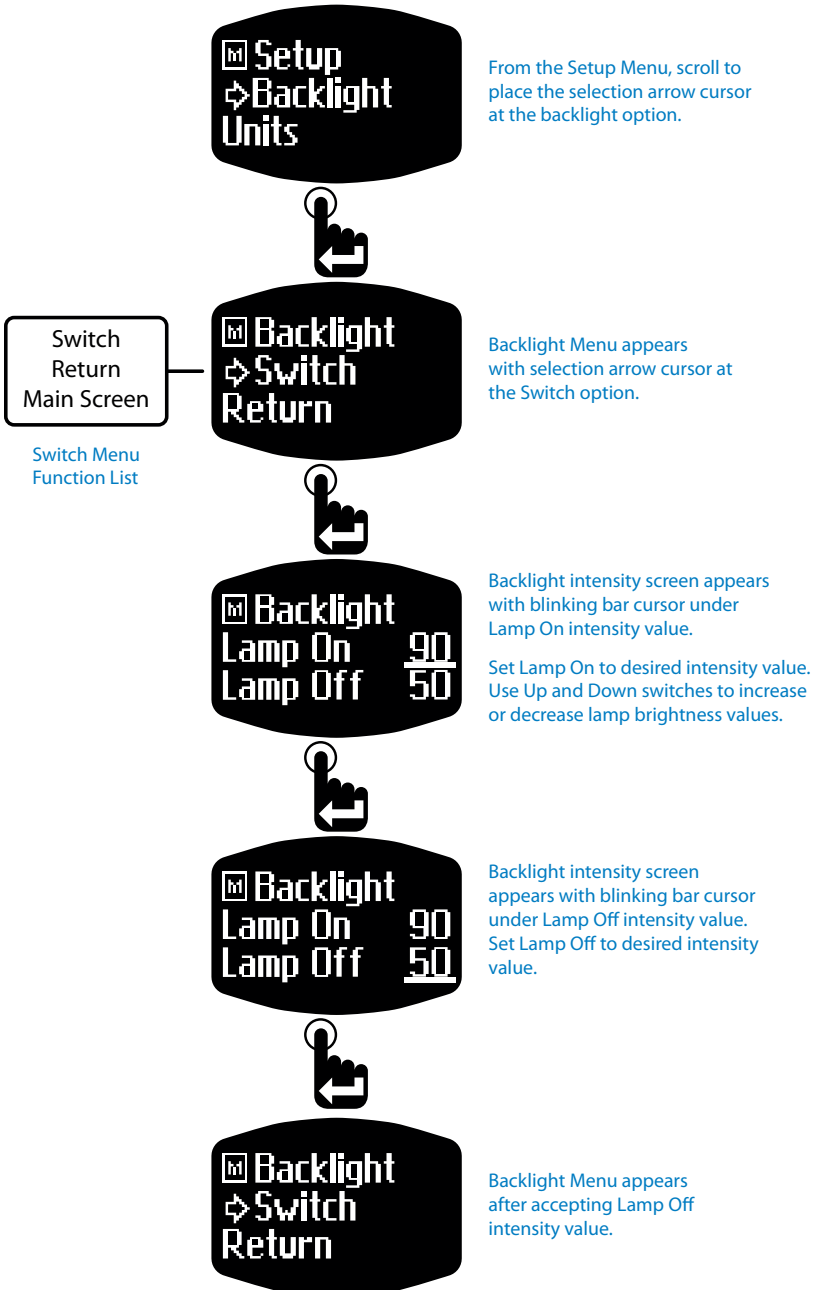

• Units

Users may choose between English and SI-Metric units for parameter display. Users may also select between statute and nautical mile for marine odometer units. If SI-Metric units is chosen, the statute and nautical mile units are displayed in kilometers.

Figure 1-19: Setting Units

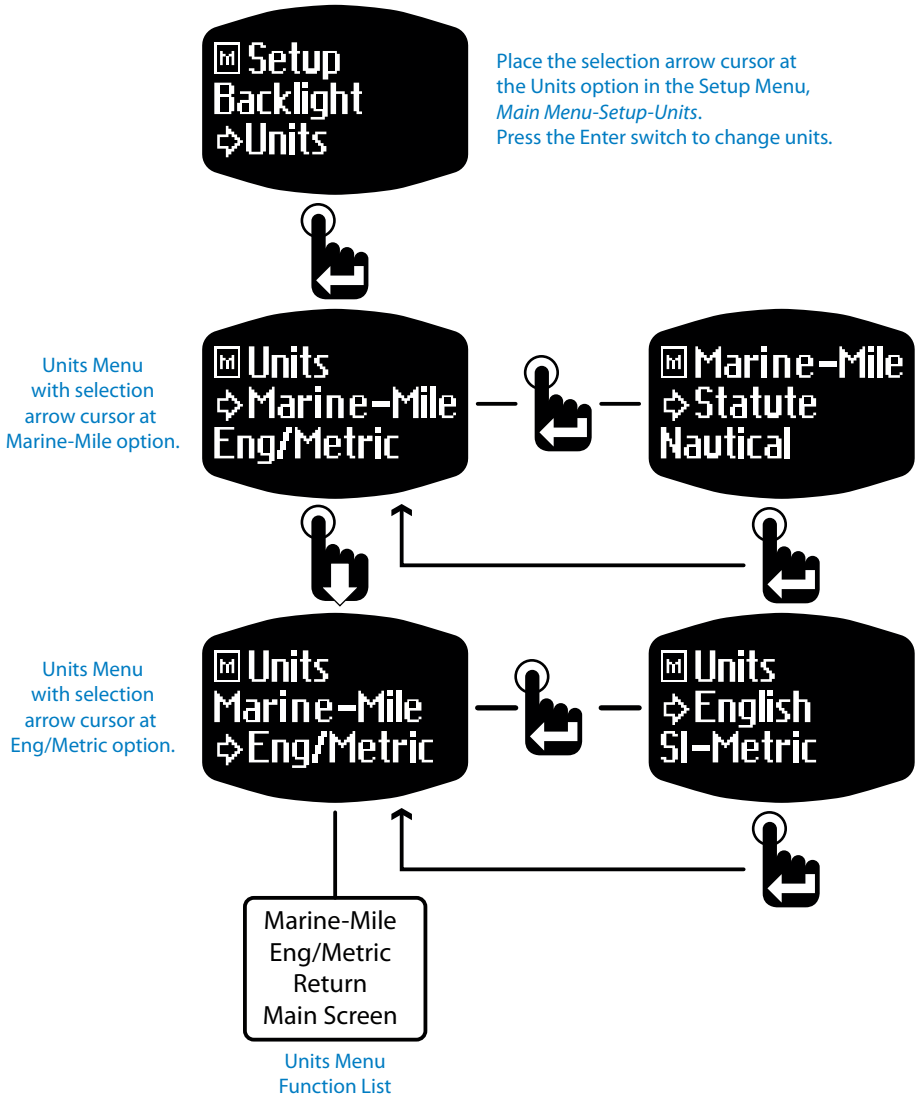

• Clock Viewing & Setting

Vantage View® offers a digital clock display screen. Users enable/disable clock display, set clock time/format and enable date display using the clock menu functions.

• Viewing & Setting

If clock display is enabled, it always appears as the last Quick View Main Screen. Refer to "Quick View Main Screens" on page 5.

Time formats include hours:minutes and hours:minutes:seconds.

Figure 1-20: Clock Viewing and Time/Date Setting

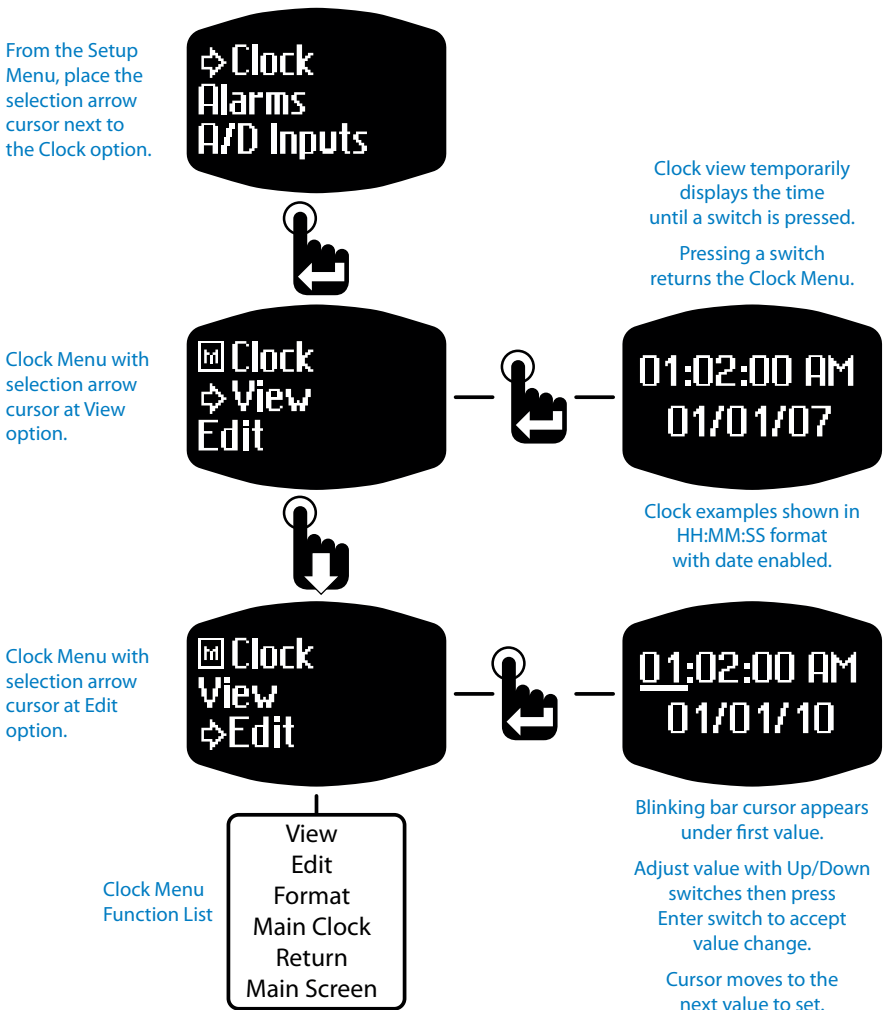

• Clock Format

The clock display format can appear as either Hours:Minutes or Hours:Minutes:Seconds. The date can be added to the clock display and appears as a second line below the time display in the format of MM/DD/YY.

Figure 1-21: Setting Clock Format and Displaying Date

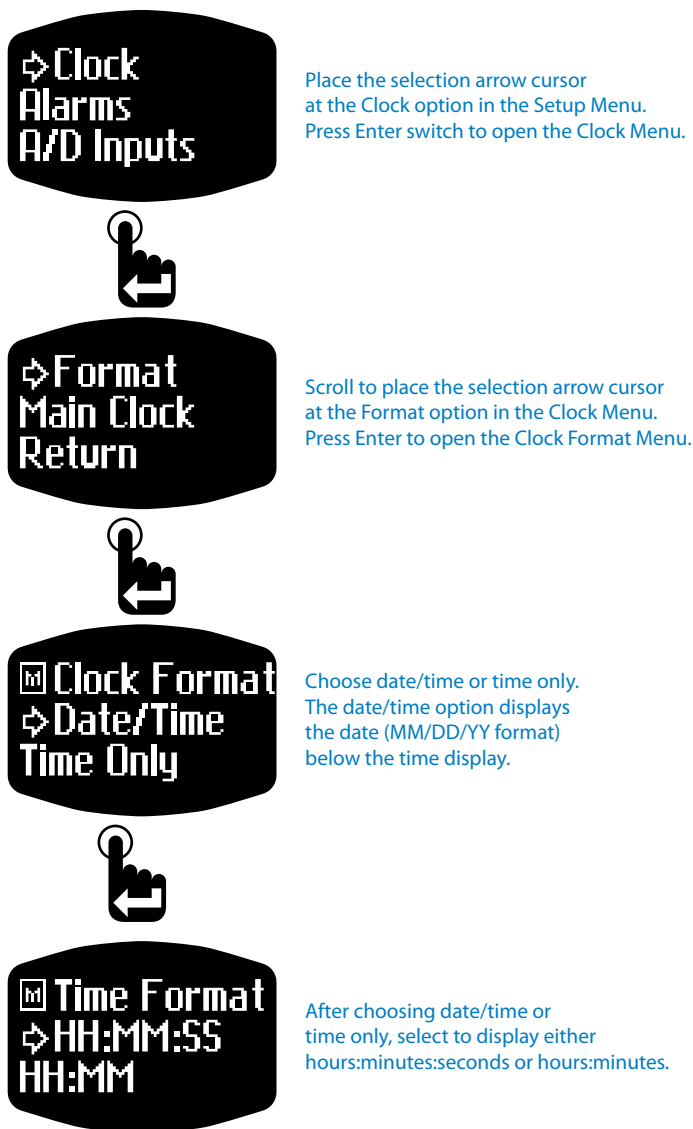

• Main Clock

The Main Clock function adds the clock as one of the Quick View Main Screens. The clock always appears as the last screen in the Quick View Main Screen list.

Figure 1-22: Enable Display of Main Clock



Place the selection arrow cursor at the Clock option in the Setup Menu. Press Enter switch to open the Clock Menu.



Scroll to place the selection arrow cursor at the Main Clock option in the Clock Menu. Press Enter to open the Main Clock Menu.



Select the "On" option to add the clock display to the Quick View Main Screens. Select "Off" to remove the clock display from the Quick View Main Screens.

• Alarms

See "Alarms" on page 14 for a description of the Alarm function. The *Setup-Alarm* function is identical to the *Main Menu-Alarm* function.

This section provides detailed descriptions of all the Alarm Menu functions

• Enabling Alarms

Alarm enable turns on or off notification when an alarm condition occurs. This function does not delete alarms or their settings from the alarm list.

To protect against operating the vehicle unaware of potentially damaging conditions, always use caution when deciding to turn off alarms.

Figure 1-23: Enabling/Disabling Alarms

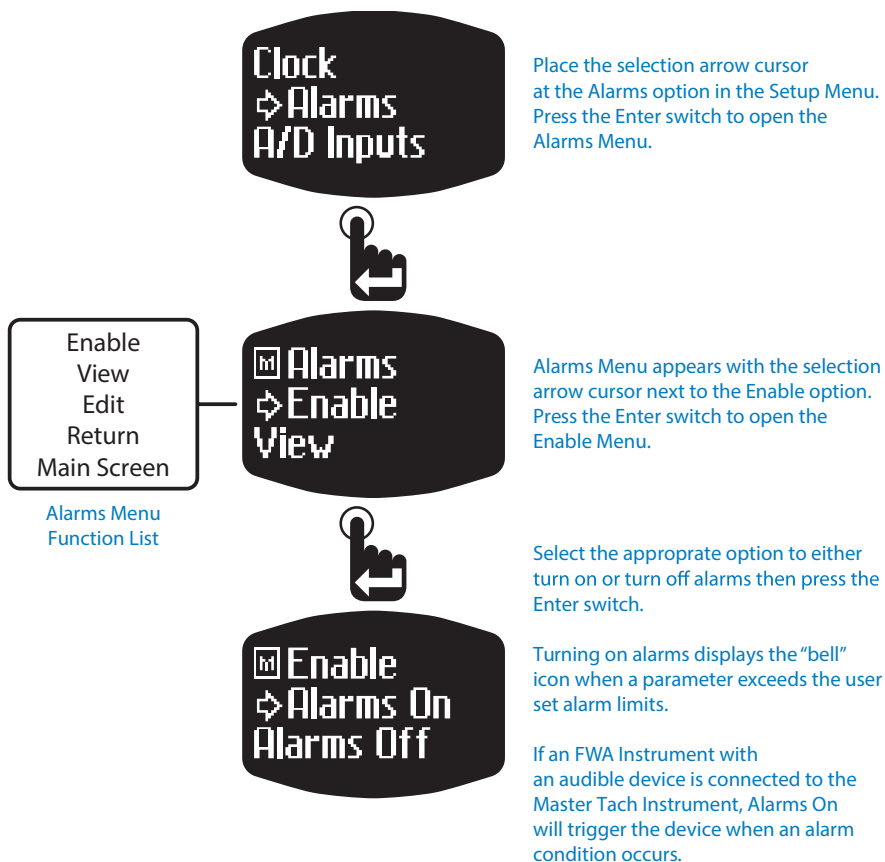

• Viewing Alarms

View Alarms allows users to scroll through all parameters causing the alarm condition or conditions. The parameter(s) causing the alarm condition will have the actual measured value blinking. To exit alarm review and return to the Quick View Main Screen, press the Mode switch.

Figure 1-24: Viewing Alarms

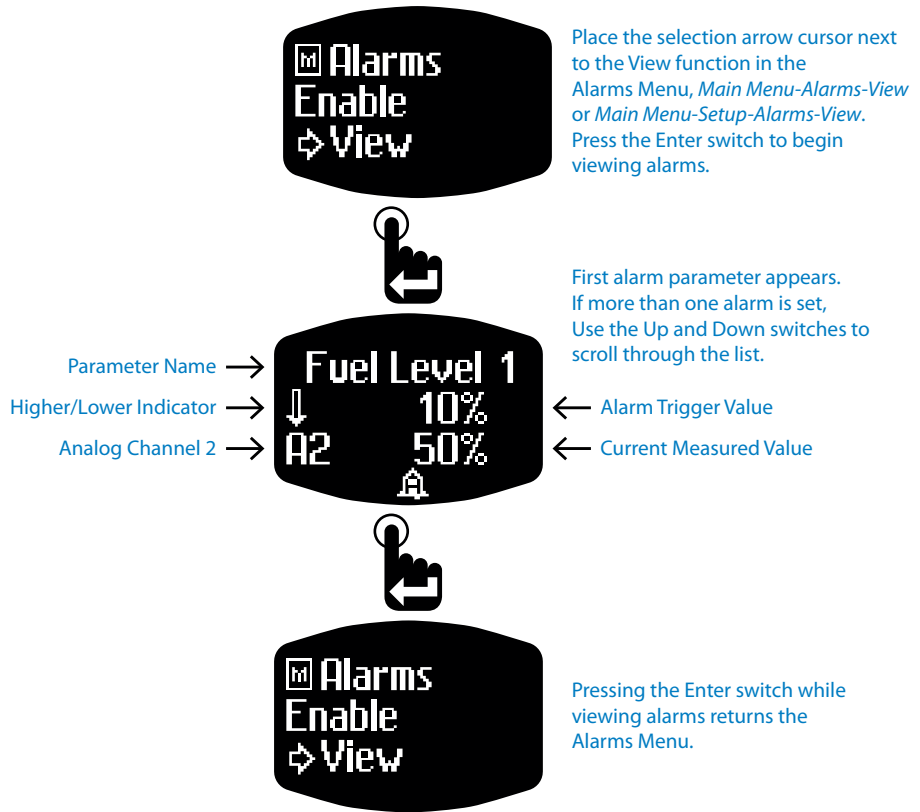

• Editing Alarms

The edit alarm function is how users add, delete and configure limits of selected CAN parameters or configured analog inputs for alarm notification. If alarms were previously set, users should view and note the current alarm parameter type, order and settings before editing.

Figure 1-25: Edit Alarms Function

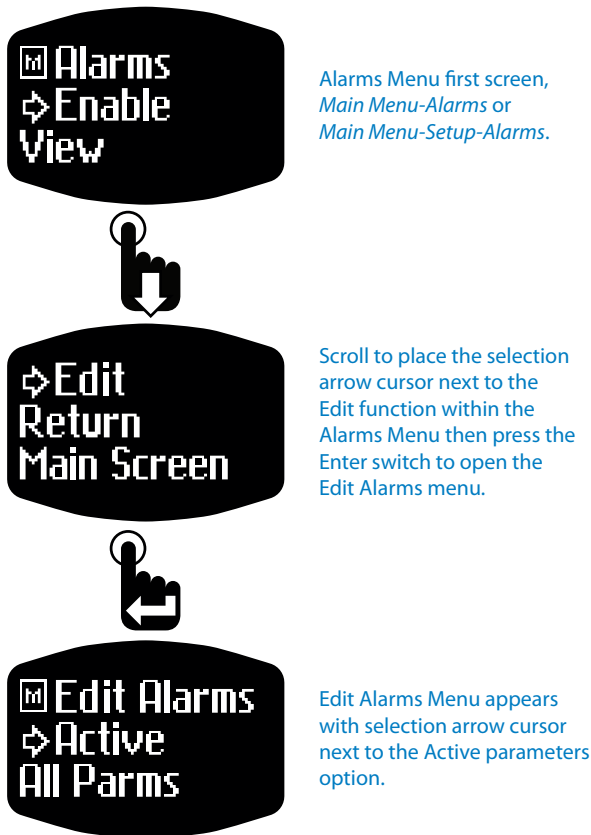

• Active & All Parameters Selection Sets

When selecting parameters for alarm notification, users can choose from the actively broadcast parameters or all parameters defined by the CAN protocol.

The active CAN parameters selection set includes those parameters that are currently or “actively” broadcast on the CAN network and read by Vantage View®. Active parameters also include any analog inputs configured using the A/D Input function. Active CAN parameters are, in most cases, a subset of the all CAN parameters set.

All CAN parameters or “All Parm’s” selection set contains all parameters defined by a specific CAN protocol standard whether or not it is currently broadcast on the CAN network and all analog inputs Vantage View® is capable of reading.

Figure 1-26: Selecting Active or All Parameters

Edit Alarms Menu
Showing
Active/All Parm’s
Selection Options



Place the selection arrow cursor next to the desired option and press the Enter switch to begin selecting parameters for alarm notification.

Active selection set includes all currently broadcast parameters and analog inputs.
All Parm’s selection set includes all parameters defined by the CAN protocol and analog inputs.

It is not recommended to select parameters from the “All Parm’s” list since the parameter may never broadcast over the CAN network and, as a result, trigger an alarm notification. Users that select parameters from the “All Parm’s” list should do so knowing the parameter or parameters will be broadcast on the CAN network to which Vantage View® instruments are connected.

• Setting Quantity of Alarms

Users can set a maximum of 15 alarms. Simply increase or decrease the alarms value in the Select Alarms screen with the Up or Down switch. Pressing the Mode switch accepts the displayed value.

Figure 1-27: Selecting Alarm Quantity

Select Alarm
Quantity Screen



Blinking bar cursor appears under select alarm quantity value. Use Up and Down switches to set desired value then press Enter switch to accept.

When no alarms are set, the alarm quantity will appear as zero (0).
If alarms are set, the alarm quantity will indicate the current number of set alarms.
Regardless of the quantity displayed, increasing the value adds a new or additional alarm to the alarm list and decreasing the value removes alarms from the list.
Changing the alarm quantity to zero (0) deletes all set alarms.

• Alarm Configuration

After setting the alarm quantity, the alarm configuration screen appears with the blinking bar cursor below the first available parameter to include as an alarm parameter.

When configuring an alarm, users must tell Vantage View® the following:

1. The parameter to use.
2. The trigger threshold direction (Higher or Lower than alarm trigger value).
3. The alarm trigger value.

Figure 1-28: Analog Parameter Alarm Configuration Screen Detail

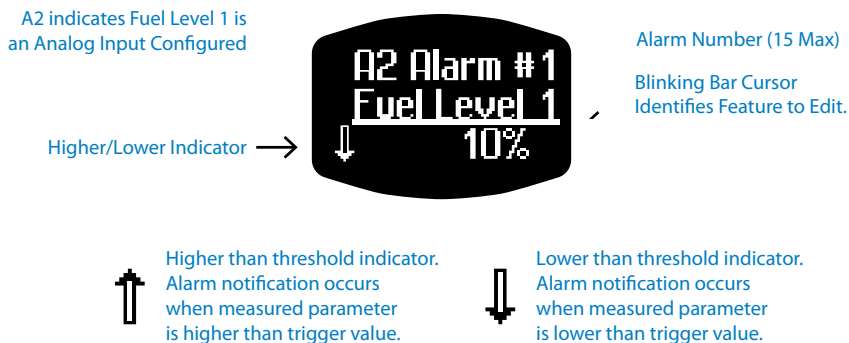

Figure 1-29: CAN Parameter Alarm Configuration Screen Detail



Parameters for selection and inclusion in the alarm list appear in random order. However, all analog input parameters appear before CAN parameters. Scroll through the parameter list with the Up and Down switches until the desired parameter appears. Press the Mode switch to add the parameter to the alarm list.

After selecting a parameter, the blinking bar cursor appears under the Higher/Lower than arrow icon. Users must choose if the alarm notification will occur when the actual parameter value is either higher or lower than the desired trigger value. Pressing either the Up or Down switch toggles the indicator between the higher than arrow (pointing up) and lower than arrow (pointing down). Press the Mode switch to accept direction of the arrow icon.

Once higher or lower is chosen, the blinking bar cursor moves to the alarm notification or trigger value. The units of this value change depending on the type of parameter chosen. Use the Up or Down switches to change the value then press the Mode switch to accept the displayed value.

If only one alarm was entered in the Select Alarms Screen, the Edit Alarms Menu reappears after setting the first alarm. If two or more alarms were entered in the Set Alarms Screen, the alarm configuration screen reappears with the blinking bar cursor beneath the parameter name awaiting selection of the next parameter to add to the alarm list. Repeat the process to add subsequent alarms if required.

Figure 1-30: Alarm Configuration

Alarm #1
Configuration Screen



Navigate to the Edit Alarms screen, *Main Menu-Alarms-Edit* or *Main Menu-Setup-Alarms-Edit*, select a parameter list and alarm quantity to bring up Alarm #1 configuration screen.

The blinking bar cursor appears under a parameter name. Use the Up and Down switches to scroll to desired parameter then press the Enter switch to accept.

Higher/Lower
Option Screen
Setting Screen

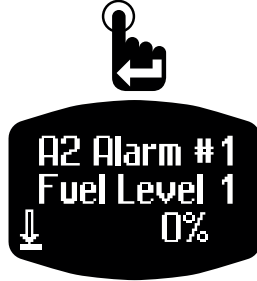

After selecting a parameter, the blinking bar cursor appears under the higher/lower than indicator.

Press either the Up or Down switch to toggle arrow direction then press Enter switch to accept direction.

Alarm Value
Setting Screen

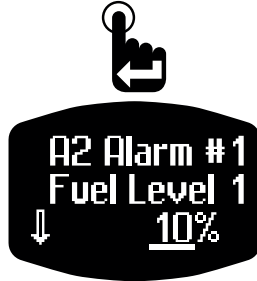

After setting higher/lower indicator, the blinking bar cursor appears under alarm indication value.

Use the Up and Down switches to set value then press Enter switch to accept.

Alarm #2
Configuration Screen



Alarm #2 configuration screen appears when setting more than one alarm. Repeat the process above to configure the alarm and all other alarms when required.

Alarms Menu

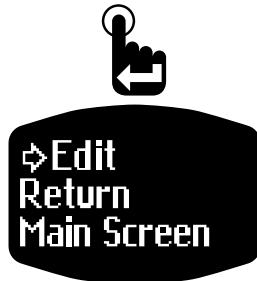

Pressing Enter switch when only one or the last alarm is set returns the Alarm Menu with the selection arrow cursor next to the Edit option.

• Adding Additional Alarms

Repeat the edit alarm process to add additional alarms. When prompted for the alarm quantity, increase it by the desired number of additional alarms. Once the alarm quantity increase is accepted, the first of all previously configured alarms appear.

Bringing up previously configured alarms gives users the opportunity to review, edit or completely change the current alarm parameters and configurations. If no changes are desired for previously configured alarms, users simply “step through” them by pressing the Mode switch to accept existing settings. If many alarms were set prior to adding additional alarms, users will need to press the Mode switch many times to leave current alarms unchanged before adding the new parameter to the alarm list.

The new alarm parameter is added to the end of the existing alarm list.

Figure 1-31: Adding Additional Alarms



• Deleting an Alarm

Repeat the edit alarm process to delete an alarm. When prompted for the alarm quantity, decrease it by the number of alarms to be removed. Vantage View® uses a last in first out (LIFO) algorithm. Therefore, decreasing the alarm quantity deletes the last alarm entered. If users wish to delete the first alarm, all alarms must be deleted and the alarms to be retained must be re-entered using the edit alarm function.

Figure 1-32: Deleting Alarm(s)



Navigate to the Select Alarms Quantity screen, *Main Menu-Alarms-Edit-Active or All Parm.*

Three previously set alarms shown as an example.



Press the Down switch to decrease the alarm quantity by the desired amount.

This example decreases the alarm quantity to two. Press the Enter switch to accept the quantity shown.



Alarm #1 screen, the first of all the previously configured alarms, appears with the blinking bar cursor beneath the parameter name.

Users may change the settings for any previously configured alarms, two in this example, or “step through” them to accept current settings using the Enter switch.

Once “stepping through” or editing of all previous alarms is complete, the selection arrow cursor appears at the Edit option in the Alarms Menu.

When deleting alarms, the last alarms entered are the first to be deleted (LIFO).

Setting alarm quantity to zero deletes all alarms.

• A/D (Analog/Digital) Inputs

Analog sender or A/D inputs are used to connect discrete non-CAN senders such as fuel level, engine trim and water pressure. Vantage View® reads the analog signal and converts it to a digital signal for processing.

Configuring A/D inputs “tells” a Vantage View® Master Tach Instrument the type of sender used and to what analog input pin the sender is connected. Users must know this combination before configuring A/D inputs. It does not matter which analog input pin is used as long as the A/D input is configured to match the physical hardware connections.

Example: If a 240-33 ohm fuel sender is wired to pin 7 (analog input 1) then users should set analog input 1 to a Fuel Level parameter with a resistance range of 240-33 ohms.

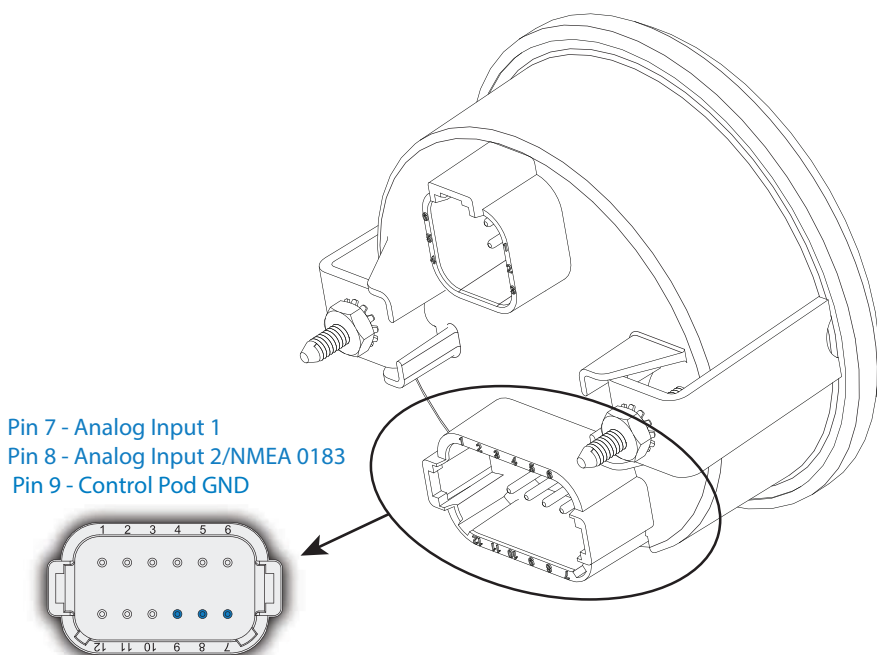

Figure 1-33: Connector Analog Input Pins

See the following page for A/D input setup display screens.

• NMEA 0183 Input

If factory configured, analog input 2 can read NMEA 0183 data from compliant devices such as GPS receivers and smart transducers.

If analog input 2 is factory configured for NMEA 0183, the only parameter options for the input are None and NMEA 0183.

Figure 1-34: A/D Input Setup

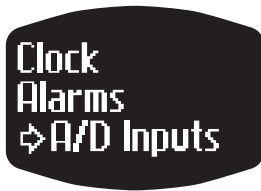

Place the selection arrow cursor at the A/D Inputs option in the Setup Menu, *Main Menu-Setup-A/D Inputs*.



The Analog Menu appears. Select the appropriate analog input. Depending on the Master Tach Instrument version, up to three inputs are available.



Select the appropriate sender type and range for the input pin. This combination configures analog input 1 (connector pin 7) to a 0-90 ohm fuel sender.



Pressing the Enter switch returns the Analog Menu to configure additional inputs if required.

Scroll down to see Input 3 (if available), Return and Main Screen options.

• A/D Pressure Sender Inputs

Configuring an analog pressure sender input differs slightly from other analog inputs. With pressure senders, users must tell Vantage View® the pressure range for the sender by inputting the pressure at 0% and 100% of full scale. This is in addition to setting the sender resistance range.

See the following diagram for configuring an analog pressure sender.

Figure 1-35: A/D Pressure Sender Input Configuration

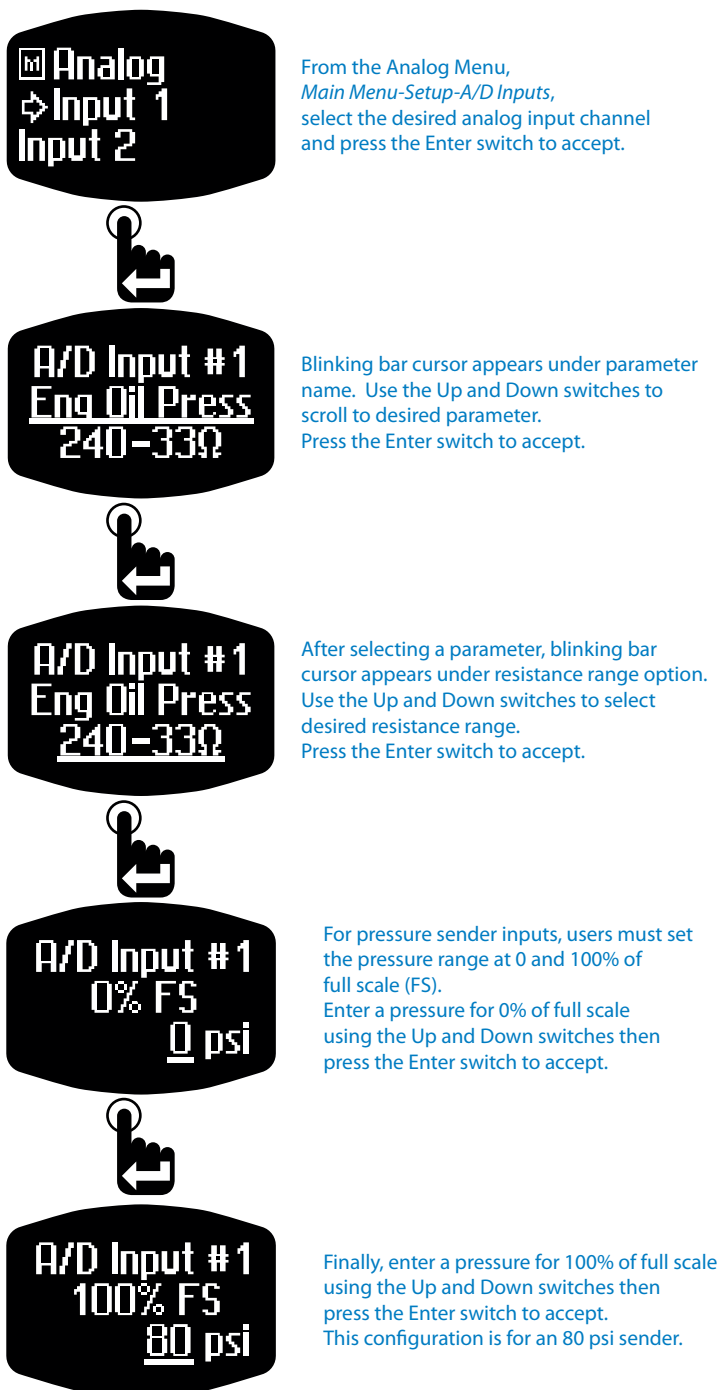

• Display

The Display Menu functions give users the ability to configure the LCD. Options for configuring the display include brightness, contrast, viewing mode and which parameters to include in the Quick View Main Screen stack. Each function is detailed in the following pages.

Figure 1-36: Display Menu

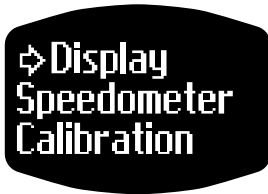

Place the selection arrow cursor at the Display option in Setup Menu, Main Menu-Setup-Display.



The Display Menu appears with the selection arrow cursor at the Main Order option.

- Main Order
- Main Trim
- Main Clock
- Main Roll
- Main Recall
- Key Off
- Set Video
- Set Contrast
- Return

Display Menu Function List (Standard)

Note: Since instruments are often factory configured to OEM specifications, some Display Menu functions in the list may not appear on your instrument.

• Main Order

The Main Order function is used to select the quantity of parameters and order in which they will display when scrolling through the Quick View Main Screens.

See following page for detailed instructions.

Figure 1-37: Quick View Main Screen Parameter Selection

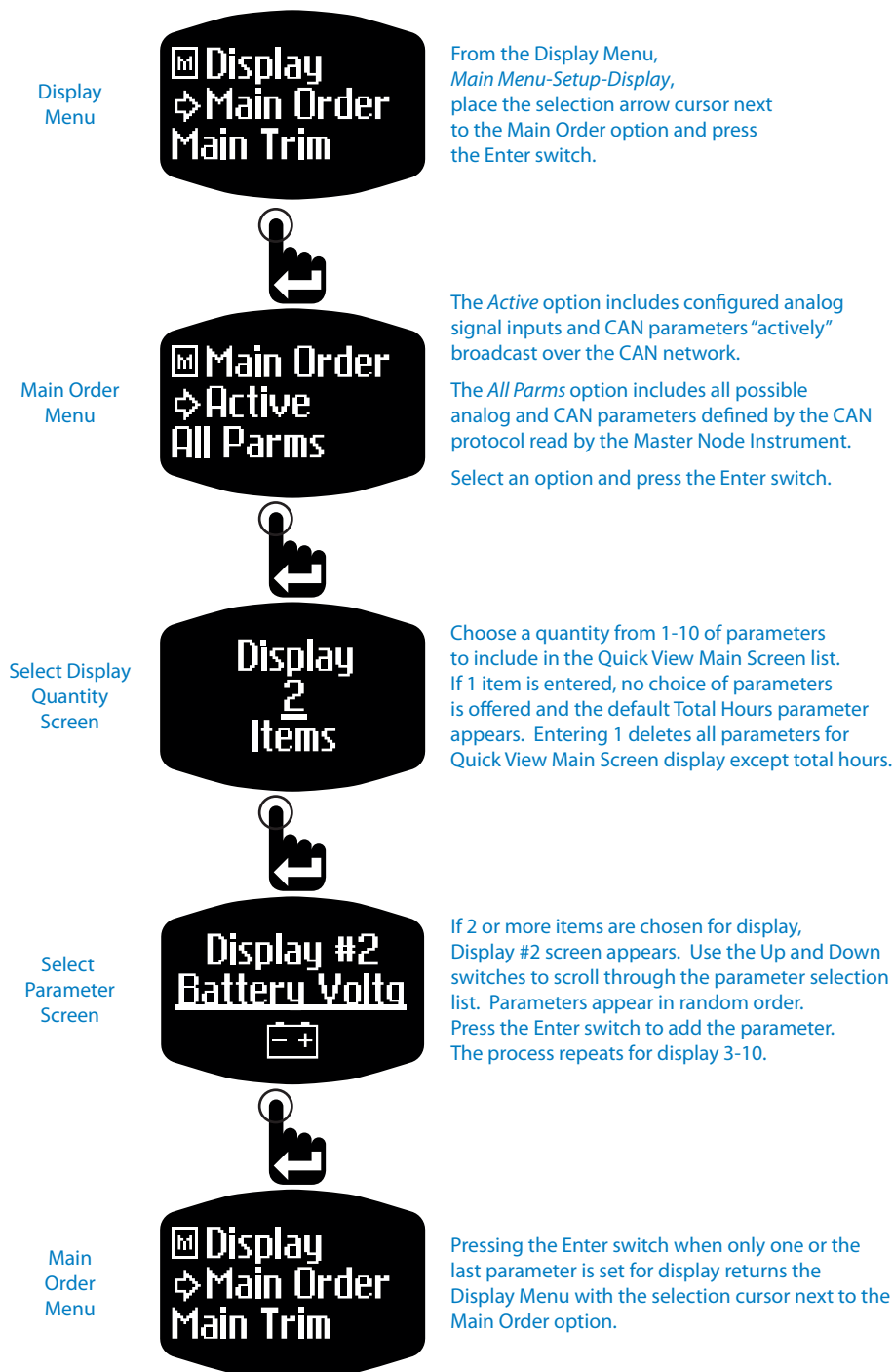

• Main Trim

Because trim is a commonly used function for NMEA 2000® configured CAN instruments, the Main Trim function provides a fast way to display engine trim and trim tab position to the Quick View Main Screens. If a vessel is equipped with engine trim and trim tabs, Main Trim consolidates all three functions on one screen. This function only works with CAN trim parameters.

When added to the screen display list in this method, the trim screen will appear last in the Quick View Screen List or second to last if Main Clock is enabled for display.

Figure 1-38: Adding Trim Parameters to Quick View Main Screen Display List

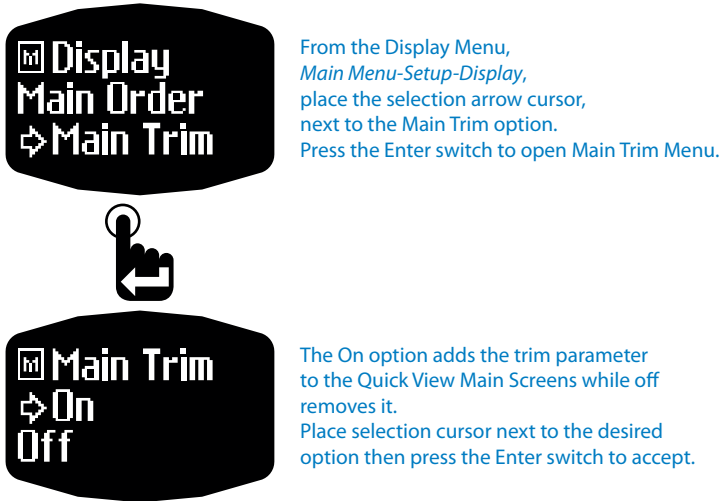

• Trim Screen Formats

Depending on the number of trim devices, the Main Trim Quick View Screen may display from one to three trim position indicators as shown in the figure below.

“E” bar graph indicates engine or outdrive trim while the “P” and “S” bar graphs indicate port and starboard trim tabs respectively.

Figure 1-39: Trim Screen Formats

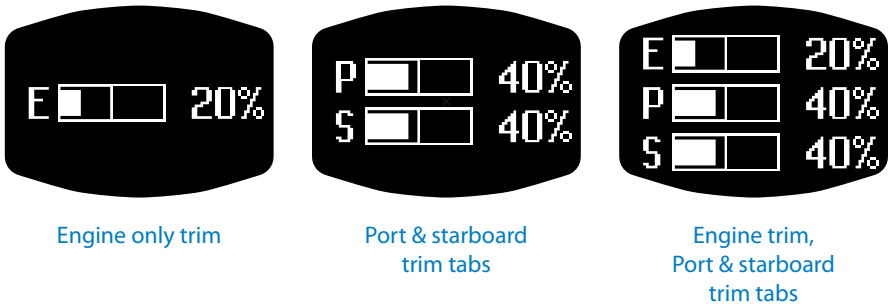

• Main Clock

Main Clock function adds a clock display to the Quick View Main Screens. The clock can also be added or removed from the Quick View Main Screens by using *Main Menu-Setup-Clock-Main Clock-On* or *Off*. The clock always appears as the last Quick View Main Screen and may not be reordered in the screen list.

Figure 1-40: Adding Clock Display to Quick View Main Screen List



Select Main Clock from the Display Menu, *Main Menu-Setup-Display-Main Clock*. The On option adds clock display to the Quick View Main Screens while off removes it. Place the selection arrow cursor next to the desired option then press the Enter switch to accept.

• Main Roll

Main Roll sets the style of scrolling through the Quick View Main Screens. With Main Roll set to Roll, pressing the Up and Down switches continuously loops through the Quick View Main Screens such that when the last screen is reached pressing the Down switch displays the first screen. With Main Roll set to No Roll, scrolling stops at the first or last Quick View Main Screen. This setting requires users to press the Up switch to scroll back up the through when the last screen is reached or press the Down switch when the first screen is displayed.

Figure 1-41: Quick View Main Screen Scrolling Style

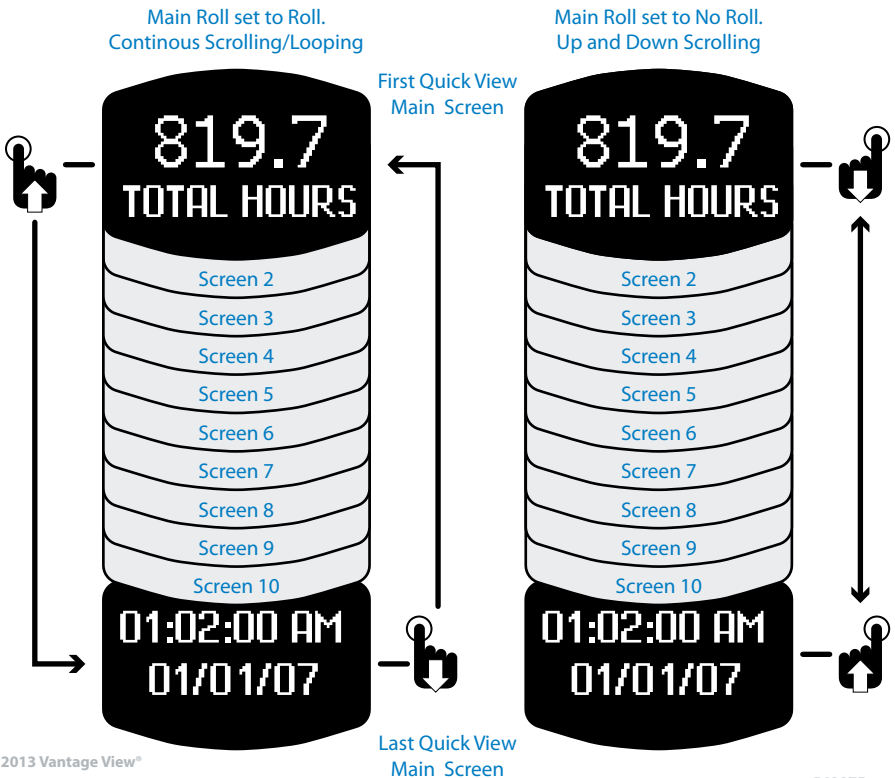
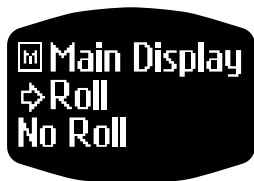

Figure 1-42: Setting Quick View Main Screen Scrolling Style



Select Main Roll from the Display Menu, *Main Menu-Setup-Display-Main Roll*. Press the Enter switch to accept.



The Main Roll Menu appears. The Roll option enables continuous scrolling/looping of Quick View Main Screens. No Roll stops screen scrolling when the top or bottom of the screen list is reached. Place the selection arrow cursor next to the desired option then press the Enter switch to accept.

• Main Recall

Recall enables Vantage View® to remember the last Quick View Main Screen displayed when the ignition key is turned off so that screen will appear when the key is turned back on. This feature eliminates the need to scroll through the Quick View Main Screens to display a preferred parameter every time the vehicle is turned off. The No Recall option returns the default Quick View Main Screen (Total Hours) when the ignition key is turned off and then back on regardless of the last screen displayed.

Figure 1-43: Setting Quick View Main Screen Recall



Select Main Recall from the Display Menu, *Main Menu-Setup-Display-Main Recall*, Press the Enter switch to accept.



The Recall option remembers the last Quick View Main Screen displayed when the ignition key is turned off so that screen will appear when the key is turned back on.

No Recall ignores the last Quick View Main Screen displayed when the ignition key is turned off.

Place selection arrow cursor next to the desired option then press the Enter switch to accept.

• Notes

Vantage View[®] NMEA 2000[®] Flow Chart

PART # LIT-GA-CANB-W-REV0617

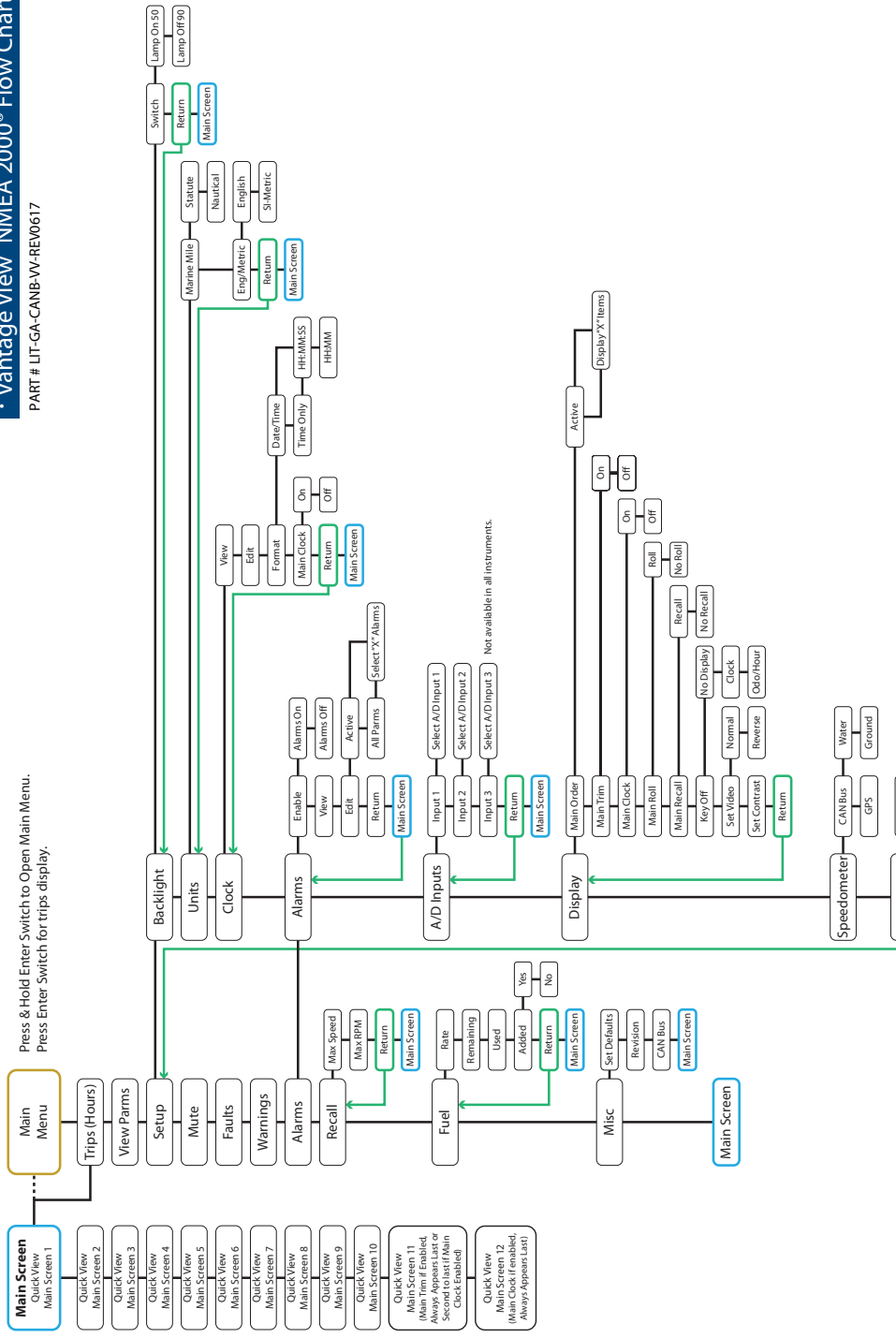

Notes:

1. As a general rule, horizontal lines within the flow chart represent pressing the Enter switch while vertical lines represent pressing the Up or Down switch.
2. The initial quantity and type of QuickView Main Screens configured for display is factory set to OEM specifications.
3. Pressing and holding the Enter switch for approximately three seconds with any screen displayed returns users to the Main Menu.
4. Several menu items are contextual and require user input to access all menu options.

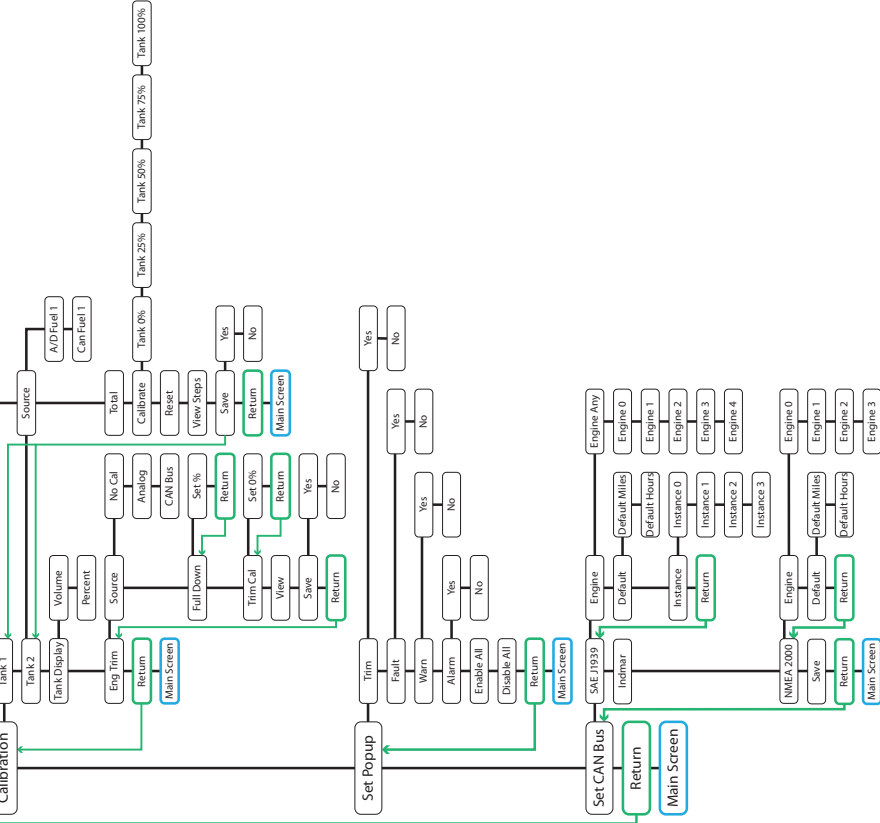

• Notes

• Key Off

Users can choose to retain the clock or ODO/Hours displays when the ignition key is turned off.

Note: This feature turns on the LCD and not the LCD backlight. The transfective nature of the LCD will allow for viewing in low ambient lighting conditions. For optimum viewing, turn the ignition key on to enable the LCD backlight. Refer to "Backlight" on page 18 for instrument illumination setup.

Figure 1-44: Setting Key Off Display Options



Select the Key Off option from the Display Menu, *Main Menu-Setup-Display-Key Off*. Press the Enter Switch to accept.

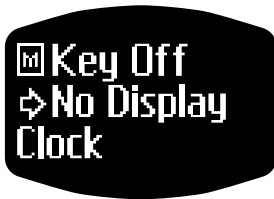

When the ignition key is turned off, the No Display option blanks or turns off the LCD.

The Clock option retains a clock display while Odo/Hours retains either the total hours or total miles display when the ignition key is turned off.

Place the selection arrow cursor next to the desired option then press the Enter switch to accept.



Pressing the Down switch scrolls to the remainder of the Key Off Menu options.

• Set Video

Setting video changes the color scheme of the LCD from white graphics on a black background (Normal) to black graphics on a white background (Reverse).

Figure 1-45: Setting LCD Background Color Scheme



Select **Set Video** from the Display Menu, *Main Menu-Setup-Display-Set Video*. Press the Enter switch to accept.



From the Video Mode Menu, users can choose **Normal** (white text on black background) or **Reverse** (Black text on white background). Place the selection arrow cursor next to the desired option then press the Enter switch to accept.

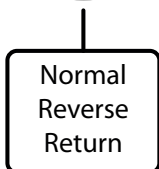

Video Mode
Function List



Set Video = Normal



Set Video = Reverse

• Set Contrast

Contrast sets the difference between the white and black colors of the LCD.

Figure 1-46: Setting LCD Contrast



Select **Set Contrast** from the Display Menu, *Main Menu-Setup-Display-Set Contrast*. Press the Enter switch to accept.

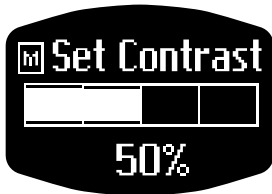

Use the Up and Down switches to increase or decrease contrast. Press the Enter switch to accept contrast setting.

• Speedometer

Vantage View® reads both CAN and GPS based speed inputs. This function tells Vantage View® what speed source to use to drive the speedometer pointer. Should more than one speed source exist, users can view all speed data on the LCD by selecting View Parm from the Main Menu. It is not necessary to set the speedometer source if the vehicles instrument set does not contain speedometer.

• CAN Speedometer

The CAN speed drives the pointer in the speedometer from a CAN source. CAN speed sources are further defined by either a water or ground based speed references.

• GPS (NMEA 0183) Speedometer

The GPS option drives the pointer in the speedometer from NMEA 0183 compliant GPS speed sources. A Vantage View® Master Tach Instrument must be factory configured with analog input 2 (Pin 8 of the twelve pin connector) dedicated to read NMEA 0183 sources. If analog input 2 is NMEA 0183 configured, users must set A/D (Analog/Digital) input 2 to NMEA 0183 using *Main Menu-Setup-A/D Inputs* prior to setting the speedometer source to GPS. Refer to page 32, setting A/D inputs.

Figure 1-47: Setting Speedometer Source

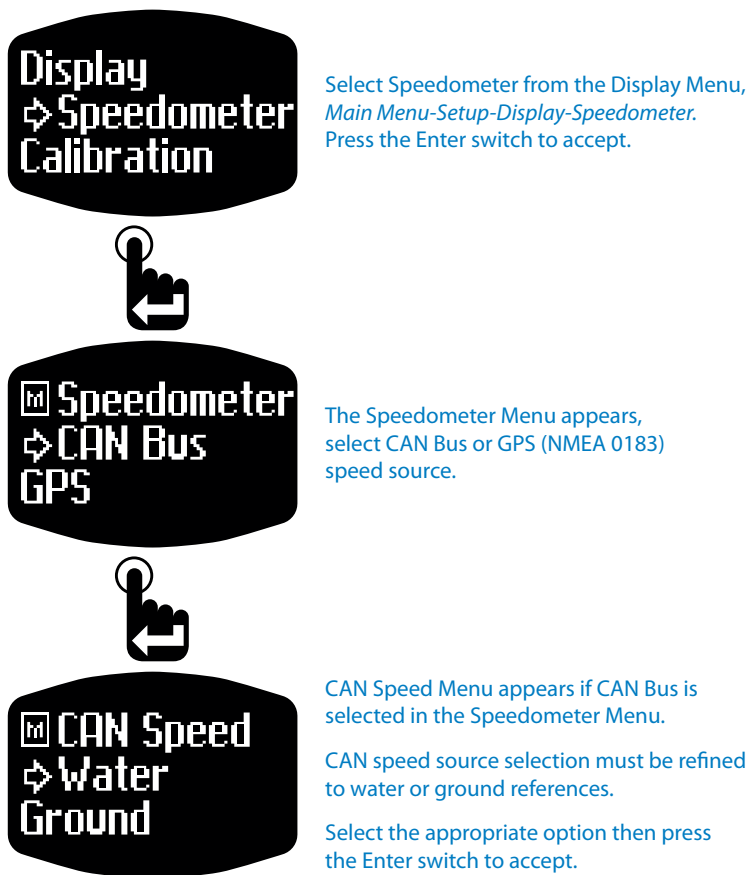

• SmartCraft® Speedometer Settings



• CAN Speedometer

The Can speed drives the pointer in the speedometer from a CAN source. Can speed sources are further defined by either Airmar, Paddle Wheel or Pitot-High or Low.

• GPS (NMEA 0183) Speedometer

The GPS option drives the pointer on the speedometer instrument from NMEA 0183 compliant GPS speed sources. A Vantage View® Master Tachometer must be factory configured with analog input 2 (Pin 8 of the twelve pin connector) dedicated to read NMEA 0183 sources. If analog input 2 is NMEA 0183 configured, users must set A/D (Analog/Digital) input 2 to NMEA 0183 using *Main Menu- Setup-A/D Inputs* prior to setting the speedometer source to GPS. Refer to page 32, setting A/D inputs.

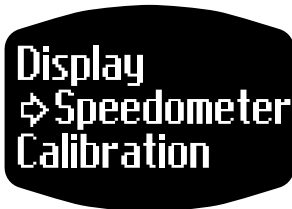

Select Speedometer from the Display Menu, *Main Menu-Setup-Display-Speedometer*. Press the Enter Switch to accept.



The Speedometer Menu appears, select Can Bus or GPS (NMEA0183) speed source.



CAN Speed Menu appears if CAN Bus is selected in the Speedometer Menu.

CAN speed source selection must be refined to Airmar, Paddle Wheel or Pitot (High or Low)

Select the appropriate option then press the Enter switch to accept.

• Calibration - Fuel Tank

The calibration function helps insure accuracy of fuel and engine trim parameters.

Calibration is a multi-step process requiring users to input characteristics of the tank or engine trim positions. Up to two fuel tanks can be calibrated. The process for calibrating tank 1 or tank 2 is identical.

Figure 1-48: Calibration Menu

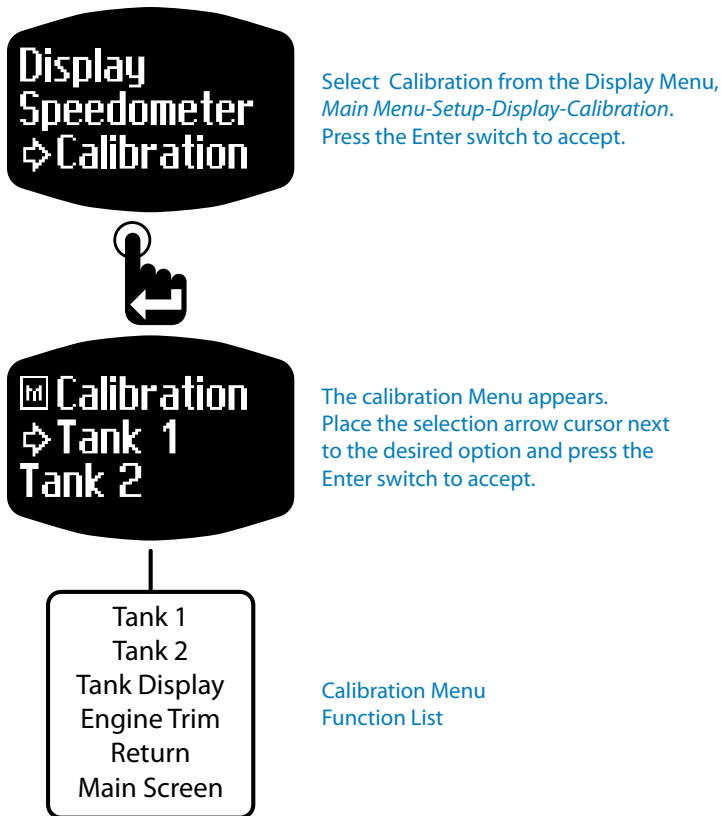

Calibration Menu function summary:

Tank 1 - Configures and calibrates fuel tank 1

Tank 2 - Configures and calibrates fuel tank 2 if necessary.

Tank Display - Sets display format of fuel remaining as a volume or percent of full when selecting *Main Menu-Fuel-Remaining*.

Engine Trim - Configures and calibrates engine trim position.

Return - Brings users back to calibration option on Display Menu.

Main Screen - Brings users back to the default Quick View Main Screen.

• Calibration Tank 1 or 2

The process calibrating a fuel tank requires entering a source for the fuel data, setting fuel tank capacity and calibrating the fuel tank level. The next several pages detail each step of the process. Calibrate, Reset and View Steps Menu options do not appear until source and capacity information is entered.

Note: Original equipment manufacturers may precalibrate tank/sender combinations.

Figure 1-49: Selecting a Fuel Tank to Configure.



Select Calibration from the Setup Menu, Main Menu-Setup-Calibration. Choose a tank to configure (1 or 2) then press the Enter switch to accept.



Tank 1 Menu appears. To begin fuel tank setup, press the Enter switch to accept source option.

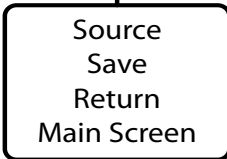

The options for Tank 1 Menu are limited to those at left until the fuel data source, total tank capacity and calibration steps are complete.

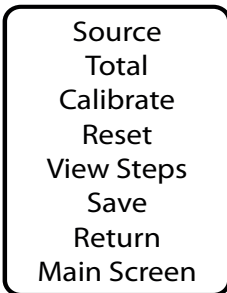

Tank 1 complete menu option list. All functions appear after setting a source, total volume and calibrating the tank.

• Setting Fuel Tank Data Source

After deciding which tank to calibrate, users must choose a source for the fuel data. The source can be a CAN parameter, A/D input (analog discrete fuel sender) or None. Selecting the None option still provides fuel level information but disables fuel management data for the tank.

If A/D input is chosen, users must first configure an analog input using the A/D Inputs setup function. Refer to "A/D (Analog/Digital) Inputs" on page 32 for configuring fuel as an A/D input.

Figure 1-50: Selecting Fuel Tank Data Source

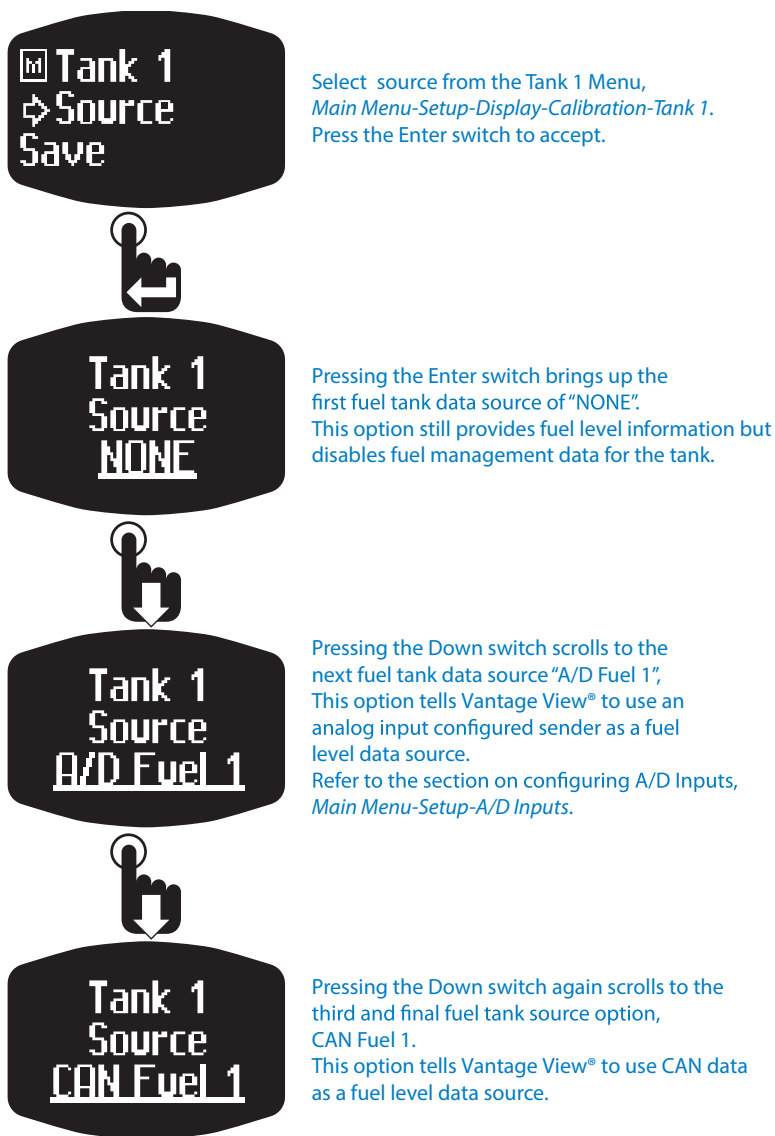

• Setting Fuel Tank Total Capacity

Setting tank capacity is the second step in the calibration process. It is important to enter an accurate capacity amount for the fuel tank since accurate fuel sender calibration relies on this information.

Figure 1-51: Setting Fuel Tank Capacity.

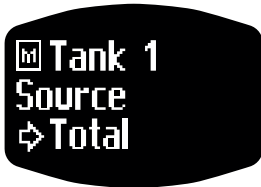

Select **Total** from the Tank 1 Menu, *Main Menu-Setup-Display-Calibration-Tank 1*. Press the Enter switch to accept.



The total tank capacity screen appears. Use the Up and Down switches to change the capacity.

Press the Enter switch once the desired capacity is displayed.



Press or press and hold the Up switch to set the tank capacity.

This example shows the tank capacity set to 80 gallons.

Pressing the Enter switch accepts the displayed value and returns the Tank 1 Menu.

• Calibrating Fuel Tank Level

The final step for calibrating fuel level indication requires characterizing the sender to the actual fuel tank level. Manually characterizing a fuel sender to the fuel tank accounts for possible fuel level errors due to complex shaped tanks and fuel sender mounting location.

A properly calibrated fuel tank is necessary to calculate accurate fuel consumption rates.

Calibrating the fuel tank level requires starting with an empty fuel tank and then filling the tank with fuel in intervals or “steps” of 25%, 50%, 75% and 100% of tank capacity by volume. At each step Vantage View® displays the current percentage of the senders full-scale range and the amount of fuel to be put in the tank. When the required amount of fuel for a calibration step is placed in the tank, pressing the Mode switch sets the current sender resistance to that amount of fuel in the tank.

Example: Calibrating an 80 gallon fuel tank requires users to set the sender resistance when the tank is empty and after placing 20, 40, 60 and 80 gallons of fuel in the tank. The following figures show each step in the process of calibrating a sample 80 gallon tank.

• Calibrating Fuel Tank Level Step 1 - Empty Tank

Figure 1-52: Setting Empty Tank Calibration Point



Select **Calibrate** from the Tank 1 Menu, *Main Menu-Setup-Calibration-Tank 1-Calibrate*. Press the Enter switch to begin tank level calibration.



The first calibration point appears for empty tank.

The percent value shown represents the amount of fuel currently in the tank as a percentage of the senders full-scale range.

At empty, this percentage may indicate the tank is not actually empty, an improperly adjusted float arm or simply within the tolerance of the sender.

Make adjustments to the fuel level or sender otherwise press the Enter switch to move to the second calibration point.

PART # LIT-GA-CANB-VV-REV0617

• Calibrating Fuel Tank Level Steps 2 thru 5

Setting the remaining calibration points for 25-100% of tank capacity is identical to setting the empty tank calibration point except for the required amount of fuel at each calibration point. The amount of fuel needed in the tank is displayed on the LCD and is based upon the total tank capacity set earlier.

The diagram below continues the process of calibrating the sample 80 gallon fuel tank. The percentages shown are used as an example only and will vary depending upon the sender characteristics.

Figure 1-53: Setting Tank Calibration Points for 25-100%

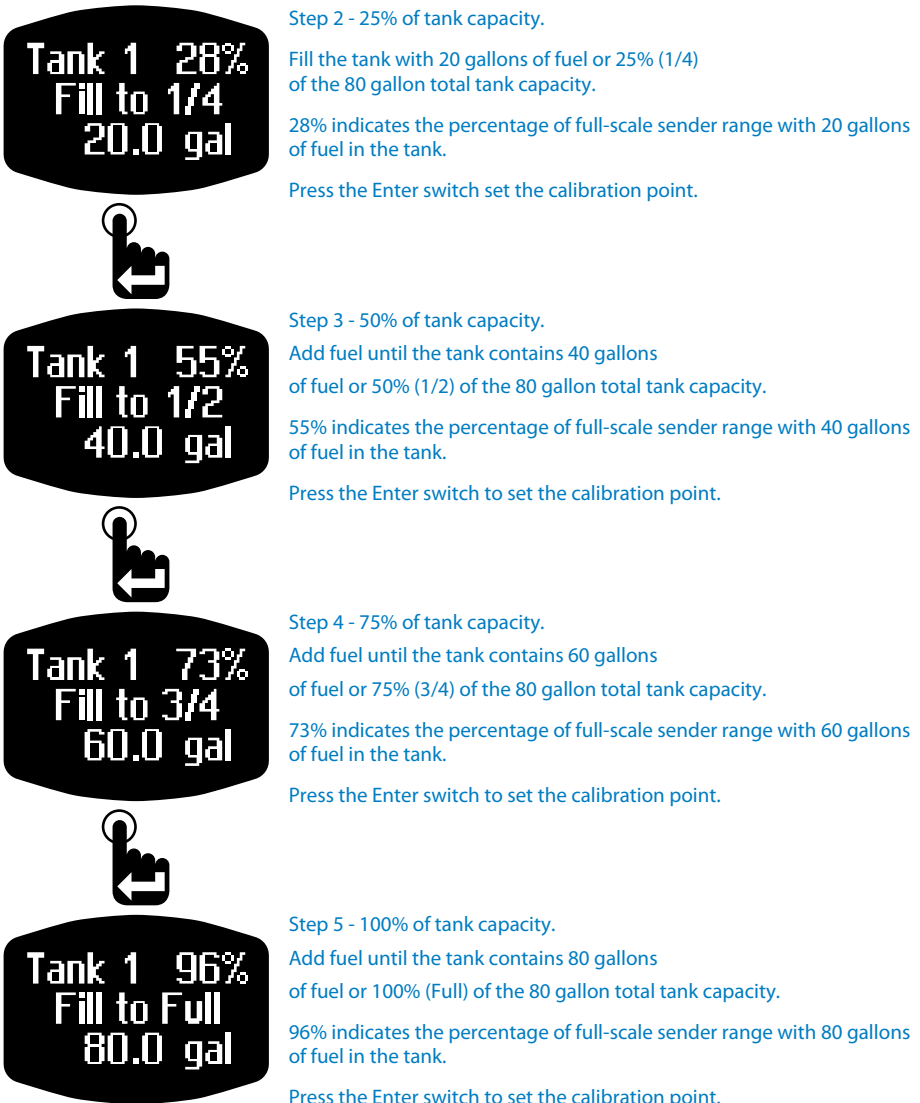

It is recommended users save calibration settings after completing step 5. See "Saving Fuel Tank Calibration Data" on page 53.

• Resetting Fuel Tank Calibration

The calibration points for a fuel tank can be reset by using the reset option found in either the Tank 1 or Tank 2 menus. This option only appears if calibration data was entered for a tank.

Figure 1-54: Resetting Fuel Tank Calibration Data Points



Select Reset from the Tank 1 Menu,
Main Menu-Setup-Calibration-Tank 1-Reset.
Press the Enter switch to begin calibration reset process.



The Reset Tank 1 Data screen appears.
Press the Enter switch to reset the tank calibration.
Tank 1 Menu reappears after pressing the Enter switch.

• Viewing Calibration Steps

Users can view/review all five calibration steps and the percent of full-scale sender range for those steps.

Figure 1-55: Viewing Fuel Tank Calibration Step 1



Select View Steps from the Tank 1 Menu,
Main Menu-Setup-Calibration-Tank 1-View Steps.
Press the Enter switch to begin reviewing calibration points.



Percent of full →



Step number
Percent of full-scale sender range
at displayed tank capacity.

← Amount of fuel needed for

Screen interpretation summary: Calibration Step 1 for
Tank 1 at empty or 0% of full-tank capacity was set at 2%
of the full-scale sender range

• Viewing Calibration Steps 2 thru 5

Pressing the Down switch after the first calibration step is displayed scrolls through the remaining calibration steps 2 thru 5.

The values shown in the figure below are from the 80 gallon tank example shown earlier. Values shown will vary for each user.

Figure 1-56: Viewing Fuel Tank Calibration Steps 2 thru 5

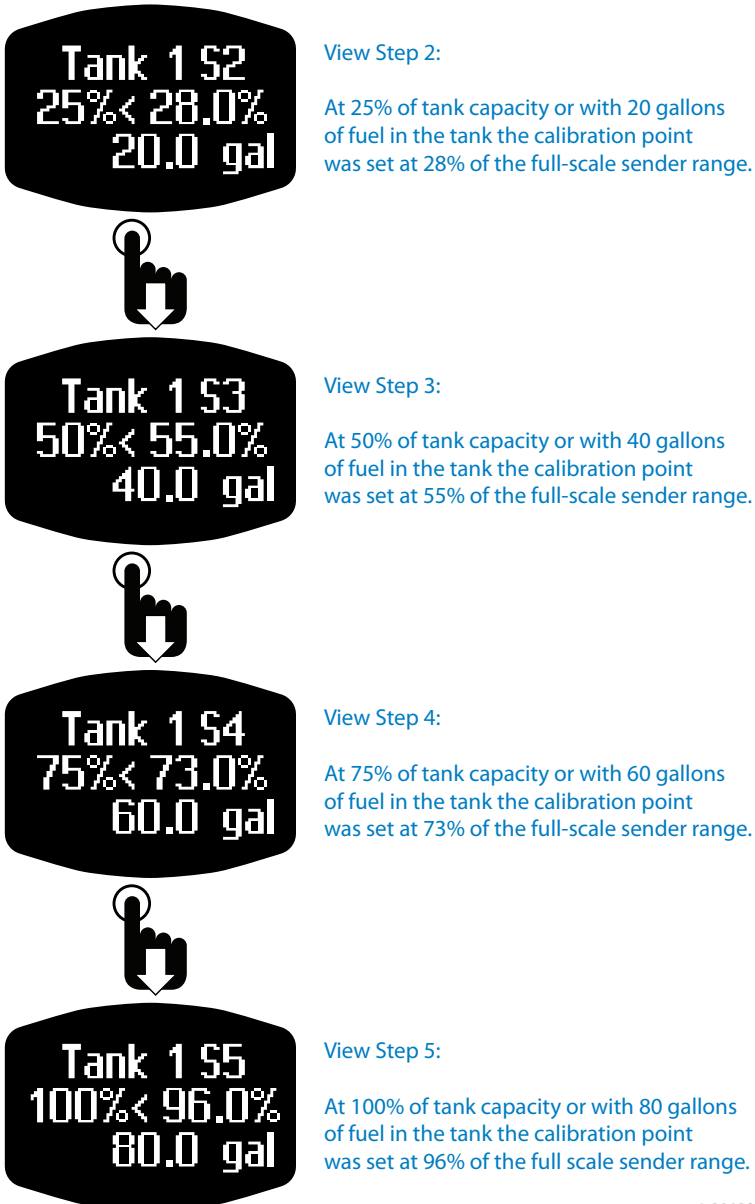

• Saving Fuel Tank Calibration Data

After making fuel tank source, capacity or calibration changes, users must save the changes for Vantage View® to retain the information.

Figure 1-57: Saving Fuel Tank Data & Calibration Steps



Select Save from the Tank 1 Menu, Main Menu-Setup-Calibration-Tank 1-Save. Press the Enter switch to open Save Tank 1 Menu.



The selection arrow cursor appears at the "No" option to prevent accidental replacement of existing data.

Move the selection arrow cursor next to the "Yes" option using the Up switch then press the Enter switch to save the calibration data.

• Tank Display

Users may select to view fuel remaining as either a volume or percent of full with the Tank Display function. This setting does not effect the fuel consumption rate display unit which remains volume per unit time such as gallons per hour (GPH).



Select Tank Display from the Calibration Menu, Main Menu-Setup-Calibration-Tank Display.

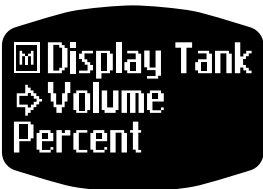

The Display Tank Menu appears with the selection arrow cursor next to the volume option. Select Volume or Percent then press the Enter switch to accept.

• Calibration - Engine Trim

The implementation and accuracy of trim senders may vary greatly on a vessel. The engine trim calibration feature allows users to characterize the engine trim position to better match the sender, satisfy personal preferences or set a safety margin to the full-up or down positions.

Engine trim calibration is a three-step process requiring users to input trim source along with full-up and full-down calibration points.

Figure 1-58: Engine Trim Calibration Menu



Select Engine Trim from the Calibration Menu, *Main Menu-Setup-Calibration-Engine Trim*, then press the Enter switch to accept.

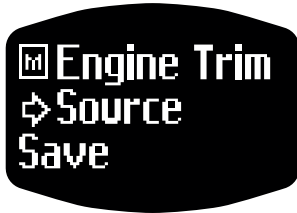

Engine Trim Menu appears with the selection arrow cursor next to the source option. Before calibrating a trim sender, a source input must be selected. Press the Enter switch to select a source.

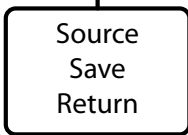

Options for the Engine Trim Menu are limited to those at left until a trim data source other than the No Cal option is selected.

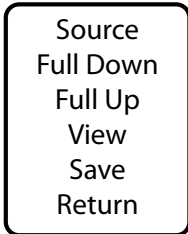

Engine Trim Menu complete option list. These functions appear after setting the engine trim data source to Analog or CAN Bus.

Engine Trim Calibration Menu function summary:

- Source - Provides options for analog, CAN Bus or No calibration (None) trim data sources.
- Full Down - Sets calibration point for full-down engine trim position.
- Full Up - Sets calibration point for full-up engine trim position.
- View - Shows previously set engine trim calibration points.
- Save - Saves any changes to engine trim calibration options.
- Return - Brings users back to the engine trim option, *Main Menu-Setup-Calibration-Engine Trim*.

• Selecting Engine Trim Sender Type for Calibration

Users may choose to calibrate either analog or CAN Bus trim sender types. A “No Cal” option permits the use of OEM sender calibration or setup. Trim senders are still read by Vantage View® when No Cal is chosen but this may result in the physical full-up or down engine trim positions not matching the full scale display on the Master Tach LCD or pointer position of a Slave trim gauge connected to the Master Tach Instrument.

Whether or not a trim sender is calibrated, analog trim senders must first be configured as an analog input using the A/D Inputs setup function in order to read the analog trim sender. Refer to "A/D (Analog/Digital) Inputs" on page 32 for configuring trim as an A/D input. CAN Bus trim senders are automatically read by Vantage View®.

Figure 1-59: Engine Trim Calibration Menu



Select Engine Trim from the Calibration Menu, Main Menu-Setup-Calibration-Engine Trim. The selection arrow cursor appears next to the source option.

Press the Enter switch to select a trim sender signal source for calibration.



The Engine Trim Menu appears with the selection arrow cursor next to the No Cal option. Select this option to use the OEM calibration or sender setup.

Move the selection arrow cursor next to Analog then press the Enter switch to select an analog type trim sender for calibration.



Scroll down farther to place the selection arrow cursor next to the CAN Bus option then press the Enter switch to select a CAN compatible trim sender for calibration.

• Calibrating Full-Down & Full-Up Trim Sender Positions

Once a trim sender source is selected, the options for calibrating the full-down and up trim positions appear. Setting full-down and up positions allows users to maximize the full trim sender range or set an offset for either or both the up or down positions.

NOTE: When calibrating Full-Down & Full-Up Trim, it is best to do so in the water- under normal operating conditions. Do not set Full-Up in a trailer position.

As an example, setting the full-up position at 80% of the full sender range creates an offset. This type of offset could be used to identify the ideal trim position for operation yet leaves room for trimming the engine higher for trailering.

Figure 1-60: Setting Full-Down Trim Position

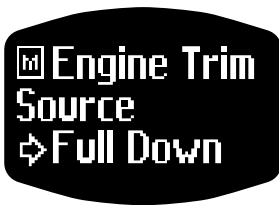

After selecting a trim sender source, select Full Down from the Engine Trim Menu, *Main Menu-Setup-Calibration-Engine Trim-Full Down*. Press the Enter switch to begin setting full-down position.



The engine trim Full Down Menu appears with the selection arrow cursor next to the No Change option.

Move the selection arrow cursor to the Set option and trim the engine to the desired down position.

As the engine is trimmed, the percent of full-scale trim value changes. If an offset for the down position is desired, trim the engine to a percent value greater than zero otherwise trim to 0%.



Once the desired percent value is reached, press the Enter switch to set the calibration point.

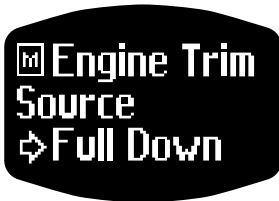

After setting the full-down position and pressing the Enter switch, the Engine Trim Menu appears with the selection arrow cursor next to the Full Down option.

Figure 1-61: Setting Full Up Trim Position



Place the selection arrow cursor next to the Full Up option in the Engine Trim Menu, *Main Menu-Setup-Calibration-Engine Trim-Full Up*. Press the Enter switch to begin setting full-up position.



The engine trim Full Up Menu appears with the selection arrow cursor at the No Change option.



Move the selection arrow cursor to the Set option and trim the engine to the desired up position.

As the engine is trimmed, the percent of full-scale trim value changes. If an offset for the up position is desired, trim the engine to a percent value less than 100% otherwise trim to 100%.

Once the desired percent value is reached, press the Enter switch to set the calibration point.

• Viewing Trim Calibration Settings

The view option provides an easy method to simultaneously review the trim settings for both up and down positions.

Figure 1-62: Viewing Engine Trim Settings

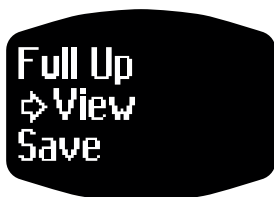

Place the selection arrow cursor next to the View option in the Engine Trim Menu, *Main Menu-Setup-Calibration-Engine Trim-View*. Press the Enter switch to view trim calibration settings.



The View E Trim screen displays the calibration settings for both the up and down positions.

• Saving Trim Calibration Settings

To retain any changes to engine trim source or calibration settings, users must save them before exiting the Engine Trim Menu.

Figure 1-63: Saving Engine Trim Settings

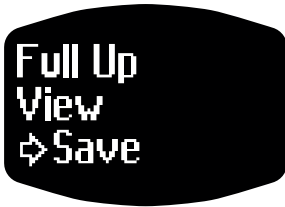

Place the selection arrow cursor next to the Save option in the Engine Trim Menu, *Main Menu-Setup-Calibration-Engine Trim-Save*. Press the Enter switch to open Save E Trim Menu.



If changes were made to either the source or calibration points, the Yes/No save options appear.

The selection arrow cursor appears next to the No option to protect against accidentally replacing existing settings.

Move the selection arrow cursor to the Yes option then press the Enter switch to save changes or settings.

Or



If no changes were made to either the source or calibration points, the Save E Trim Menu appears displaying No Change.

Press the Enter switch to return to the Engine Trim Menu.

• Set Popup

Turning on popups provide a highly visible alert screen when a system fault, warning or alarm occurs.

Figure 1-64: Popup Fault, Warning & Alarm Screens



When popups are enabled, the following screens appear if a fault, warning or alarm occurs.

Fault, warning and alarm popup screens remain displayed until acknowledged by pressing either the Mode, Up or Down switches. Pressing the Mode switch returns the screen that was active when the fault, warning or alarm condition occurred but a blinking icon appears at the bottom of the screen to indicate a fault, warning or alarm condition exists. Pressing the Up or Down switch brings up the detail screen for the alarm condition.

Note: If the condition that caused the fault, warning or alarm clears, the notification screens and icons will disappear as well.

Figure 1-65: Acknowledging Fault, Warning or Alarm Notification



Pressing the Enter switch returns the screen displayed prior to the fault, warning or alarm with a blinking icon appropriate to the condition.

(Total hours shown as an Example)

Pressing the Up or Down switches displays a screen with details about the fault, warning or alarm. (Check engine shown as an Example)

• Trim Popup Function

Since engine trim and trim tab positions are frequently adjusted, enabling the popup feature for trim temporarily brings up the appropriate trim detail screen when a change in trim position occurs. This feature allows users to see the trim position screen yet have the prior screen reappear several seconds after trim adjustments are completed.

Figure 1-66: Popup Engine/Tab Trim Screen



With any Quick View Main Screen displayed and trim popup enabled, changing the trim of the vessel automatically brings up the engine trim screen.

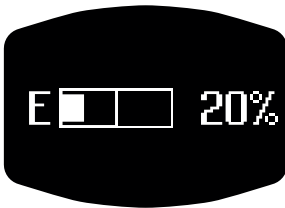

The trim screen remains active while trim adjustments are made.

Several Seconds
of No Trim Changes



After a short period of time with no trim activity detected, the previously displayed Quick View Main Screen returns.

• Popup Menu

The Popup Menu is found in the setup section of the Main Menu and provides all the options for enabling/disabling popup screens. Users can turn on popups for each feature individually or use the Enable/Disable All function to turn on popups for all features in one step.

Figure 1-67: Popup Menu



Select Set Popup from the Setup Menu, Main Menu-Setup-Set Popup. Press the Enter switch to accept.



Set Popup Menu appears with the selection arrow cursor next to the Trim option. Move selection arrow cursor to desired Set Popup option then press the Enter switch to set popup state.

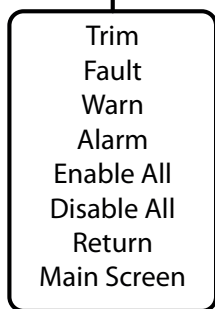

Set Popup Menu function list.

The Enable All and Disable All options will not appear if all popups are already set to on or off respectively.

• Enabling/Disabling Popup Features

Enabling or disabling the popup feature for trim, fault, warning and alarm functions requires navigating to the Set Popup Menu found within the Setup Menu and selecting which function to set. Simply choose yes or no to enable or disable the popup for each function.

To enable or disable the popup feature for all four functions simultaneously, the Enable All or Disable All menu option provides this functionality.

Refer to the next several diagrams for setting the popup state for the various functions.

Figure 1-68: Setting Trim Popup State



Select Set Popup from the Setup Menu, Main Menu-Setup-Set Popup. Press the Enter switch to accept.

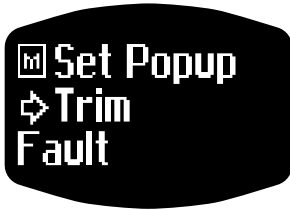

Set Popup Menu appears with the selection arrow cursor next to the trim option. Press the Enter switch to set trim popup state.



Popup Trim Menu appears. Selection arrow cursor location depends upon current state of trim popup.

If trim popup is on, the arrow will appear next to "Yes" option and if off next to "No" option.

Select "Yes" to turn on trim popup and "No" to turn off trim popup.

Figure 1-69: Setting Fault Popup State



Select Fault option from the Set Popup Menu, *Main Menu-Setup-Set Popup-Fault*. Press the Enter switch to set fault popup state.



Popup Fault Menu appears. Selection arrow cursor location depends upon current state of fault popup.

If fault popup is on, the arrow will appear next to "Yes" option and if off next to "No" option.

Select "Yes" to turn on fault popup and "No" to turn off fault popup.

Figure 1-70: Setting Warning Popup State



Select Warn option from the Set Popup Menu, *Main Menu-Setup-Set Popup-Warn*. Press the Enter switch to set warning popup state.



Popup Warn Menu appears. Selection arrow cursor location depends upon current state of warning popup.

If warning popup is on, the arrow will appear next to "Yes" option and if off next to "No" option.

Select "Yes" to turn on warning popup and "No" to turn off warning popup.

Figure 1-71: Setting Alarm Popup State



Select Alarm option from the Set Popup Menu, *Main Menu-Setup-Set Popup-Alarm*. Press the Enter switch to set alarm popup state.



Popup Alarm Menu appears. Selection arrow cursor location depends upon current state of alarm popup.

If alarm popup is on, the arrow will appear next to "Yes" option and if off next to "No" option.

Select "Yes" to turn on alarm popup and "No" to turn off alarm popup.

Figure 1-72: Enable All Popup Functions



If available, select Enable All option from the Set Popup Menu, *Main Menu-Setup-Set Popup-Enable All*. Press the Enter switch to enable popup state for all functions.



The All Popup Active screen appears after selecting Enable All.

Figure 1-73: Disable All Popup Functions



If available, select Disable All option from the Set Popup Menu, *Main Menu-Setup-Set Popup-Disable All*. Press the Enter switch to enable popup state for all functions.

The All Popup Inactive screen appears after selecting disable all.

• Set CAN Bus - SAE Master Tachometers

The Vantage View SAE Master Tachometer is configured with several CAN protocols from which users can select. The Set CAN Bus function allows users to change to a desired protocol.

Note: Use the *Main Menu-Miscellaneous-CAN Bus* function to view the currently set protocol.

Set CAN Bus Menu allows users to set the engine number to which a Master Tach Instrument is connected in multiple engine applications. See "Setting SAE J1939 Engine Number" on page 68 and also "Setting NMEA 2000® Engine Number" on page 71.

The Set CAN Bus Menu is also used to set the Default Quick View Main Screen 1 to display either total miles or total hours. See "Setting SAE J1939 Default Quick View Main Screen 1 (Total Hours or Miles)" on page 69 and also "Setting NMEA 2000® Default Quick View Main Screen 1 (Total Hours or Miles)" on page 72

Figure 1-74: Setting CAN Bus Protocol



Select Set CAN Bus from the Setup Menu, *Main Menu-Setup-Set CAN Bus*. Press the Enter switch to accept.



The Set CAN Bus Menu appears with the selection arrow cursor next to the first available CAN protocol. Move the selection arrow cursor to the desired protocol and press the Enter switch to select.

After selecting a protocol, scroll to the save option and press the Enter switch to save and set the protocol selection.

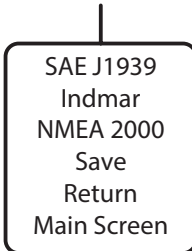

Set CAN Bus Menu function list.

Depending upon the factory setting of the Master Tach Instrument, not all protocols listed will be available.

Set CAN Bus Menu function summary:

- SAE J1939 - Sets the CAN protocol a Master Tach Instrument reads to SAE J1939.
- NMEA 2000 - Sets the CAN protocol a Master Tach Instrument reads to NMEA 2000®.
- Save - Saves the engine CAN protocol setting.
- Return - Brings users back to the Set CAN Bus Setup Menu option.
- Main Screen - Brings users back to the default Quick View Main Screen.

• Set Can Bus - SmartCraft Master Tachometers

The SmartCraft® Master Tachometer does not contain other CAN protocols, it is strictly for interpreting SmartCraft® data.



• Multiple Engine Applications

Multiple engine applications require a Master Tach Instrument for each engine. Each engine has a unique CAN identification "engine number". The "engine number" is set by either the engine manufacturer or the OEM that implements the engine. Vantage View® supports up to four engines per vehicle or vessel.

In order to read CAN data from an engine in multiple engine configurations, each Vantage View® Master Tach Instrument must be "told" the engines number from which it will read CAN data and be wired to that engines ignition key switch.

If either requirement is incorrect, the Master Tach Instrument will not power up or read data from the engine when the engines ignition key is turned on.

When wired properly, determining if a Master Tach Instrument is synced to the proper engine number simply requires turning on the ignition key switch and waiting to see if engine hours accumulate. If engine hours do not accumulate or the message "No Data" appears, use the *Main Menu-Setup-Set CAN Bus* tool to change the engine number of the Master Tach Instrument until the Master Tach reads CAN data from the desired engine.

For procedure on setting the engine number for SAE J1939, see "Setting SAE J1939 Engine Number" on page 68

For procedure on setting the engine number for NMEA 2000®, see "Setting SAE J1939 Default Quick View Main Screen 1 (Total Hours or Miles)" on page 69

Figure 1-75: Engine Sync No Data Message



"No Data" appears when the Master Tach Instrument is not synced to the proper engine number.

• Single Engine Applications

The default engine number for single engine application is 0 (zero) for NMEA 2000® and SmartCraft®. The default engine number for single engine application IS "ANY" for SAE J1939.

Should a problem exist reading CAN data from an engine due to the engine number, users should set the engine numbers back to the factory settings of 0 (zero) for NMEA 2000® and 'ANY' for SAE J1939.

• Setting SAE J1939 Engine Number

To display data from a vehicle or vessel running multiple engines and using the SAE J1939 protocol, users must sync the Master Tach Instrument to the engine number from which it will read CAN data. The diagram below illustrates the steps to set the engine number.

Note: Single engine applications do not require setting the engine number as the factory setting of "ANY" enables reading the engines CAN data.

Figure 1-76: Setting SAE J1939 Engine Number



Navigate to the Set CAN Bus Menu, *Main Menu-Setup-Set CAN Bus.*

Move the selection arrow cursor to the SAE J1939 option and press the Enter switch to select.



The SAE J1939 Menu appears with the selection arrow cursor next to the Engine option.

Press the Enter switch to open engine number selection screen.



For single engine applications, selecting the "ANY" option automatically sets the engine number from which Vantage Vi@will read CAN data.

Press the Enter switch to accept "ANY" option.

For multiple engine applications press the Up switch to see the next engine number to use.



For multiple engine applications users must choose an engine number from which a Master Tach Instrument will read CAN data. The number options range from 0-4.

Use the Up switch to scroll to the other engine number options if necessary. Press the Enter switch to accept the displayed engine number.

• Setting SAE J1939 Default Quick View Main Screen 1 (Total Hours or Miles)

When Using the SAE J1939 protocol, users have the option to set Total Hours or Total Miles as the default Quick View Main Screen 1.

See "Default Quick View Main Screen" and "Quick View Main Screens" on page 5.

Figure 1-77: Setting SAE J1939 Default Quick View Main Screen 1

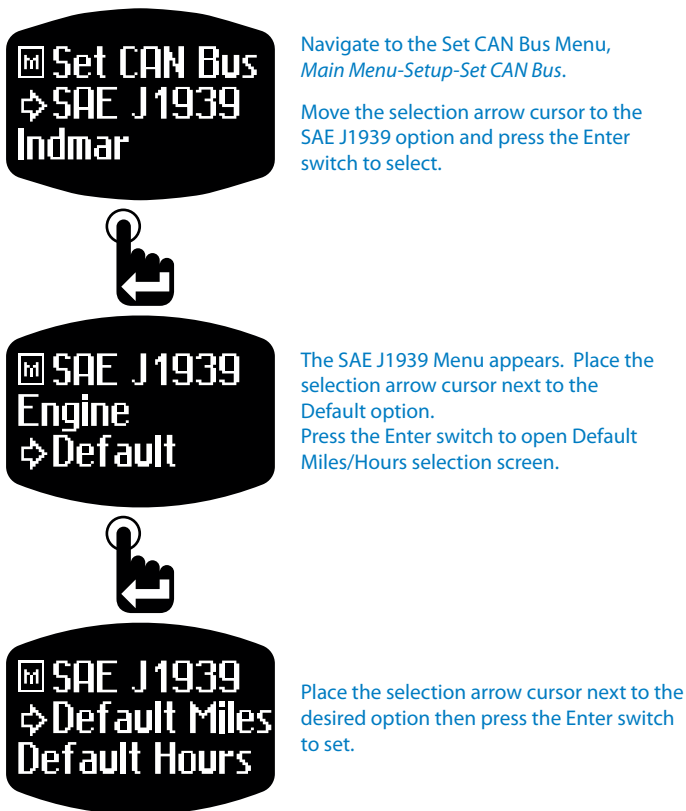

• Setting Master Tach Instrument Instance Number (SAE J1939)

Vantage View® allows for up to four Master Tach Instruments to be connected to a single engine. This is often done when applications require a Master Tach Instrument in the cabin or at the helm as well as another location such as the engine compartment or engine room.

When using the SAE J1939 CAN protocol and multiple Master Tach Instruments with a single engine, users must set an instance number for each Master Tach Instrument in order to read CAN data from the engine. The instance number for each Master Tach Instrument must be unique.

Figure 1-78: Setting Master Tach Instrument Instance Number

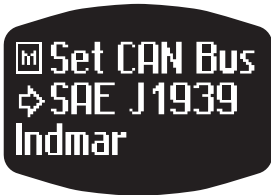

Navigate to the Set CAN Bus Menu, *Main Menu-Setup-Set CAN Bus*.

Move the selection arrow cursor to the SAE J1939 option and press the Enter switch to select.



The SAE J1939 Menu appears with the selection arrow cursor next to the Engine option. Press the Down switch to scroll to the Instance option.



With the selection arrow cursor next to the Instance option, press the Enter switch to open the instance number selection screen.



The default Instance number 0 (zero) appears. Press the Enter switch to accept the number or use the Up switch to scroll to the other instance number options. The instance numbers range from 0-4.

Note: When using multiple Master Tach Instruments with a single engine, each Master Tach Instrument connected to the engine must have a unique instance number. A maximum of four Master Tach Instruments may be connected to an engine.

• Setting NMEA 2000® Engine Number

To display data from a vehicle or vessel running multiple engines and using the NMEA 2000® protocol, users must sync the Master Tach Instrument to the engine number from which it will read CAN data. The diagram below illustrates the steps to set the engine number.

Note: Single engine applications do not require setting the engine number as the factory settings enable reading the engines CAN data. The default engine number for single engine applications is 0 (zero)

Figure 1-79: Setting NMEA 2000® Engine Number

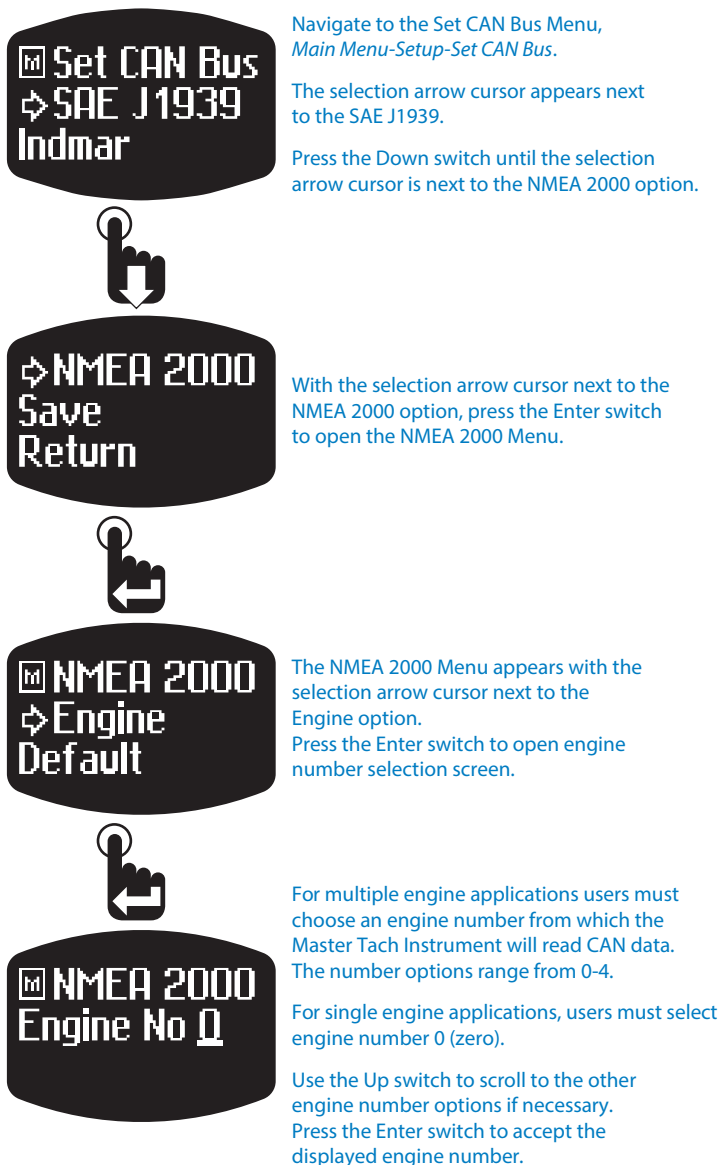

• Setting NMEA 2000® Default Quick View Main Screen 1 (Total Hours or Miles)

When using the NMEA 2000® protocol, users have the option to set Total Hours or Total Miles as the default Quick View Main Screen 1.

See "Default Quick View Main Screen" and "Quick View Main Screens" on page 5.

Figure 1-80: Setting NMEA 2000 Default Quick View Main Screen 1



Navigate to the Set CAN Bus Menu, *Main Menu-Setup-Set CAN Bus*.

The selection arrow cursor appears next to the SAE J1939.

Press the Down switch until the selection arrow cursor is next to the NMEA 2000 option.



With the selection arrow cursor next to the NMEA 2000 option, press the Enter switch to open the NMEA 2000 Menu.

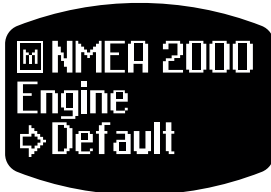

The NMEA 2000 Menu appears with the selection arrow cursor next to the Engine option. Scroll to place the selection arrow cursor at the Default option then press the Enter switch to open Default Miles/Hours selection screen.



Place the selection arrow cursor next to the desired option then press the Enter switch to set.

• Setting SmartCraft® Engine Number



Figure 1-81: Setting SmartCraft® Engine Number



Navigate to the Set Can Bus Menu. Main Menu-Set Can Bus. Move the selection arrow cursor to the SmartCraft option and press the Enter switch to select.



The SmartCraft Menu appears with the selection arrow cursor next to the Engine option. Press the Enter switch to open the engine number selection screen.

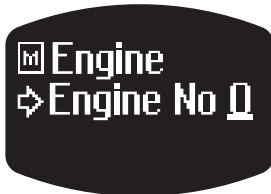

For multiple engine applications users must choose an engine number from which a Master Tachometer instrument will read CAN data. The number options range from 0-4.

Use the Up switch to scroll to the other engine number options if necessary. Press the Enter switch to accept the displayed engine number.

• Saving Set CAN Bus Changes

After changing the CAN protocol configuration to read the proper engine number, instance number and/or the display of hours or miles for default Quick View Main Screen display, users must save the changes before exiting the Set CAN Bus Menu to apply the changes.

When a CAN protocol change is made and saved, the Master Tach Instrument will reset. A screen indicating a reset is pending appears followed by the start-up routine

Figure 1-82: Saving Set CAN Bus Changes

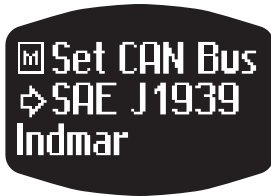

Navigate to the Set CAN Bus Menu, *Main Menu-Setup-Set CAN Bus.*

The selection arrow cursor appears next to the SAE J1939.

Press the Down switch until the selection arrow cursor is next to the Save option.



With the selection arrow cursor next to the Save option, press the Enter switch to save changes.

When a CAN protocol change is made and saved, the Master Tach Instrument will reset.

• Saving Set Can Bus Changes- SmartCraft®



After changing the proper engine numbers for SmartCraft®, users must save the changes before exiting the Set CAN Bus Menu to apply the changes.



• Analog Input Parameters Table			
Parameter	Range	Analog Input	LCD Display Name
Block Pressure	0-200 PSI	240-33Ω/10-180Ω	Block Press
Boost Pressure	0-200 PSI	240-33Ω/10-180Ω	Boost Press
Brake Application Pressure	0-200 PSI	240-33Ω/10-180Ω	Brake Appl Pr
Brake Primary Pressure	0-200 PSI	240-33Ω/10-180Ω	Brake Prim Pr
Brake Secondary Pressure	0-200 PSI	240-33Ω/10-180Ω	Brake Sec Prs
Coolant Level	0-100%	240-33Ω/10-180Ω/0-90Ω	Coolant Level
Engine Oil Level	0-100%	240-33Ω/10-180Ω/0-90Ω	Eng Oil Lvl
Engine Oil Pressure	0-200 PSI	240-33Ω/10-180Ω	Eng Oil Press
Front Air Pressure	0-150 PSI	240-33Ω/10-180Ω/0-90Ω	Front Air
Fresh Water Level	0-100%	240-33Ω/10-180Ω/0-90Ω	Fresh Wat Lvl
Fuel Delivery Pressure	0-200 PSI	240-33Ω/10-180Ω	Fuel Press
Fuel Level 1	0-100%	240-33Ω/10-180Ω/0-90Ω/Centroid 3	Fuel Level 1
Fuel Level 2	0-100%	240-33Ω/10-180Ω/0-90Ω/Centroid 3	Fuel Level 2
Generic Level	0-100%	240-33Ω/10-180Ω/0-90Ω	Misc Level
Generic Pressure	0-400 PSI	240-33Ω/10-180Ω	Misc Pressure
Hydraulic Oil Level	0-100%	240-33Ω/10-180Ω/0-90Ω	Hydr Oil Lvl
Hydraulic Oil Pressure	0-200 PSI	240-33Ω/10-180Ω	Hydr Oil Pres
Inside Temperature	-4 - 104 °C	10K Thermistor	Inside Air Tm
Outside Temperature	-4 - 104 °C	10K Thermistor	Outside Air Tm
Rear Air Pressure	0-150 PSI	240-33Ω/10-180Ω/0-90Ω	Rear Air
Rudder Angle	-100° - 100°	240-33Ω/10-180Ω/0-90Ω	Rudder Angle
Steering Angle	-100° - 100°	240-33Ω/10-180Ω/0-90Ω	Steer Angle
Transmission Oil Level	0-100%	240-33Ω/10-180Ω/0-90Ω	Trns Oil Lvl
Transmission Oil Pressure	0-400 PSI	240-33Ω/10-180Ω	Trns Oil Pres
Trim	0-100%	240-33Ω/10-180Ω/ 0-90Ω/167-10Ω	Trim Position
Washer Fluid Level	0-100%	240-33Ω/10-180Ω/0-90Ω	Washer Level
Waste Water Level	0-100%	240-33Ω/10-180Ω/0-90Ω	Waste Wat Lvl
Water Temperature	-4 - 104 °C	10K Thermistor	Water Temp
GPS Compass	0-360°	NMEA 0183	GPS Compass
GPS Heading	0-360°	NMEA 0183	GPS Heading
GPS Speed	0-200 MPH	NMEA 0183	GPS Speed
Latitude	-180° - 180°	NMEA 0183	Latitude
Longitude	-180° - 180°	NMEA 0183	Longitude
Speed (Water Reference)	0-200 MPH	NMEA 0183	Water Speed
Water Depth	0-999'	NMEA 0183	Water Depth
Water Temperature	-4 - 104 °C	NMEA 0183	Water Temp

• Vantage View® Implementation of NMEA 2000® Parameters

Parameter Name	Source	Range	LCD Display Name
Engine RPM	PGN 127488	0-10,000 RPM	Engine Speed
Engine Boost Pressure	PGN 127488	0-400 PSI	Boost Press
Engine Tilt/Trim	PGN 127488	0-100%	Engine Trim
Engine Oil Pressure	PGN 127489	0-400 PSI	Oil Pressure
Engine Oil Temperature	PGN 127489	0-500 °F	Oil Temp
Engine Temperature	PGN 127489	0-500 °F	Engine Temp
Engine Alternator Voltage	PGN 127489	0-100 Volts	Alt Voltage
Engine Fuel Rate	PGN 127489	0-800 GPH	Fuel Rate
Engine Coolant Pressure	PGN 127489	0-400 PSI	Coolant Press
Engine Fuel Pressure	PGN 127489	0-400 PSI	Fuel Pressure
Engine Status Check Engine	PGN 127489	0-1 (Off-On)	Check Engine
Engine Status Over Temperature	PGN 127489	0-1 (Off-On)	Eng Over Tmp
Engine Status Low Oil Pressure	PGN 127489	0-1 (Off-On)	Low Oil Press
Engine Status Low Oil Level	PGN 127489	0-1 (Off-On)	Low Oil Level
Engine Status Low Fuel Pressure	PGN 127489	0-1 (Off-On)	Low Fuel Pres
Engine Status Low System Voltage	PGN 127489	0-1 (Off-On)	Low Voltage
Engine Status Coolant Level	PGN 127489	0-1 (Off-On)	Coolant Level
Engine Status Water Flow	PGN 127489	0-1 (Off-On)	Water Flow
Engine Status Water in Fuel	PGN 127489	0-1 (Off-On)	Water in Fuel
Engine Status Charge Indicator	PGN 127489	0-1 (Off-On)	Charge Indict
Engine Status Preheat Indicator	PGN 127489	0-1 (Off-On)	Preheat Indict
Engine Status High Boost Pressure	PGN 127489	0-1 (Off-On)	Hi Boost Pres
Engine Status Rev Limit Exceeded	PGN 127489	0-1 (Off-On)	Rev Limit Exc
Engine Status EGR System	PGN 127489	0-1 (Off-On)	EGR System
Engine Status Throttle Position Sensor	PGN 127489	0-1 (Off-On)	Throttle Pos
Engine Status Engine Emergency Stop Mode	PGN 127489	0-1 (Off-On)	Eng Emer Stop
Engine Status Warning Level 1	PGN 127489	0-1 (Off-On)	Warn Level 1
Engine Status Warning Level 2	PGN 127489	0-1 (Off-On)	Warn Level 2
Engine Status Power Reduction	PGN 127489	0-1 (Off-On)	Power Reduct
Engine Status Maintenance Needed	PGN 127489	0-1 (Off-On)	Maint Needed
Engine Status Engine Comm Error	PGN 127489	0-1 (Off-On)	Eng Comm Err
Engine Status Sub or Secondary Throttle	PGN 127489	0-1 (Off-On)	Sub Throttle
Engine Status Neutral Start Protect	PGN 127489	0-1 (Off-On)	Neutral Start
Engine Status Engine Shutting Down	PGN 127489	0-1 (Off-On)	Eng Shut Dn
Engine Percent Load	PGN 127489	0-124%	Percent Load
Engine Total Hours	PGN 127489	0-999999 Hours	Total Hours
Engine Percent Torque	PGN 127489	0-124%	Percent Torq
Transmission Oil Pressure	PGN 127493	0-500 PSI	Tran Oil Pres

• Vantage View® Implementation of NMEA 2000® Parameters			
Parameter Name	Source	Range	LCD Display Name
Transmission Oil Temperature	PGN 127493	0-500 °F	Tran Oil Temp
Transmission Status - Check Transmission	PGN 127493	0-1 (Off-On)	Trans Check
Transmission Status - Over Temperature	PGN 127493	0-1 (Off-On)	Trn Over Tmp
Transmission Status - Low Oil Pressure	PGN 127493	0-1 (Off-On)	Trn Low Oil P
Transmission Status - Low Oil Level	PGN 127493	0-1 (Off-On)	Trn Low Oil L
Transmission Status - Sail Drive	PGN 127493	0-1 (Off-On)	Trans Sail Dr
Transmission Gear	PGN 127493	0-2 (Fwd-N-Rev)	Trans Gear
Rudder Angle	PGN 127245	-180 - 180°	Rudder Angle
Fuel Rate Average	PGN 127497	0-800 GPH	Fuel Rate Avg
Fuel Rate Economy	PGN 127497	0-800 GPH	Fuel Rate Eco
Instantaneous Fuel Economy	PGN 127497	0-800 GPH	Inst Fuel Eco
Level - Fuel	PGN 127505	0-100%	Fuel Level
Level - Fresh Water	PGN 127505	0-100%	Fresh Water
Level - Waster Water	PGN 127505	0-100%	Waste Water
Level - Live Well	PGN 127505	0-100%	Live Well Lvl
Level - Oil	PGN 127505	0-100%	Oil Level
Level - Black Water (Sewage)	PGN 127505	0-100%	Black Water
Battery Voltage	PGN 127508	0-100%	Battery Voltg
Battery Current	PGN 127508	-250 - 250 Amps	Battery Currn
Level - Fuel 2	PGN 127505	0-100%	Fuel Level 2
Level - Fresh Water 2	PGN 127505	0-100%	Fresh Water 2
Level - Waste Water 2	PGN 127505	0-100%	Waste Water 2
Level - Live Well 2	PGN 127505	0-100%	Live Well 2
Level - Oil 2	PGN 127505	0-100%	Oil Level 2
Level - Black Water (Sewage) 2	PGN 127505	0-100%	Black Water 2
Speed (Water Reference)	PGN 128259	0-200 MPH	Water Speed
Speed (Ground Reference)	PGN 128259	0-200 MPH	Ground Speed
Water Depth Transducer	PGN 128267	0-2000 Feet	Water Depth
Water Depth Transducer Offset	PGN 128267	-100 - 100 Feet	Wat Dpth Offs
Latitude	PGN 129025	-90 - 90°	Latitude
Longitude	PGN 129025	-180 - 180°	Longitude
Water Temperature	PGN 130310	-50 - 200 °F	Sea Water
Outside Ambient Air Temperature	PGN 130310	-100 - 200 °F	Outsd Air Tmp
Atmospheric Pressure	PGN 130310	0-100 PSI	Atm Pressure
Port Trim Tab	PGN 130576	0-100%	Port Tab
Starboard Trim Tab	PGN 130576	0-100%	Starboard Tab
Water Pressure	PGN 130314	-400 - 400 PSI	Water Press
Speed Over Ground	PGN 129026	0-200 MPH	GND Speed
Total Cumulative Distance	PGN 128275	0-999999 Miles	Tot Distance

• Vantage View® Implementation of SAE J1939 Parameters

Parameter Name	SPN	PGN	Range	LCD Display Name
Accelerator Pedal Position 1	91	61443	0-100%	Accel Pedal %
Engine Air Inlet Pressure	106	65270	0-72 PSI	Air Inlet Prs
Alternator Current	115	65271	0-250 Amps	Alt Current
Charging System Potential	167	65271	0-50 Volts	Alternator
Altitude	580	65256	-1000 - 18,000 Feet	Altitude
Amber Warning Lamp	624	N/A	0-1 (Off-On)	Amb Warn Lmp
Engine Average Fuel Economy	185	65266	0-200 MPG	Avg Fuel Econ
Barometric Pressure	108	65269	0-16 PSI	Barometric Prs
Net Battery Current	114	65271	-125 - 125 Amps	Battery Curr
Battery Potential/Power Input 1	168	65271	0-50 Volts	Battery Volt
Engine Intake Manifold #1 Pressure	102	65270	0-72 PSI	Boost Press
Brake Application Pressure	116	65274	0-140 PSI	Brake Appl Pr
Brake Primary Pressure	117	65274	0-140 PSI	Brake Prim Pr
Brake Secondary Pressure	118	65274	0-140 PSI	Brake Sec Prs
Aftertreatment 1 SCR Catalyst Reagent Concentration	3516	64923	0-100%	Cat Regnt Con
Aftertreatment 1 SCR Catalyst Reagent Type	3521	64923	0-14	Cat Regnt Typ
Aftertreatment 1 SCR Catalyst Tank Level	1761	65110	0-100%	Cat Tank Lvl
Aftertreatment 1 SCR Catalyst Tank Level 2	3517	65110	0-100%	Cat Tank Lvl2
Aftertreatment 1 SCR Catalyst Tank Temperature	3031	65110	-40 - 400 °F	Cat Tank Temp
Aftertreatment 1 SCR Catalyst Reagent Temperature 2	3515	64923	-40 - 400 °F	Cat Tank Tmp2
Engine Crankcase Pressure	101	65263	-36 - 37 PSI	Cnkcase Press
Compass Bearing	165	65256	0-360°	Compass Bear
Engine Coolant Level	111	65263	0-100%	Coolant Level
Engine Coolant Pressure	109	65263	0-72 PSI	Coolant Press
Engine Coolant Temperature	110	65262	0-400 °F	Coolant Temp
Cruise Control Active	595	65265	0-1 (Off-On)	Cruise Set
Transmission Current Gear	523	61445	-6 - 30 Position	Current Gear
Drive Axle Temperature	578	65273	0-400 °F	Dr Axle Temp
Engine Oil Level	98	65263	0-100%	Eng Oil Level
Engine Oil Pressure	100	65263	0-140 PSI	Eng Oil Press
Engine Oil Temperature 1	175	65262	0-500 °F	Eng Oil Temp
Engine Total Hours of Operation	247	65253	0-999999 Hours	Engine Hours
Engine Speed	190	61444	0-10,000 RPM	Engine Speed
Engine Exhaust Gas Temperature	173	65270	0-3000 °F	Exh Gas Temp

• Vantage View® Implementation of SAE J1939 Parameters

Parameter Name	SPN	PGN	Range	LCD Display Name
Fire Apparatus Pump Engagement	2599	61448	0-1 (Off-On)	Fire App Pump
Engine Instantaneous Fuel Economy	184	65266	0-200 MPG	Fuel Economy
Fuel Level 1	96	65276	0-100%	Fuel Level 1
Fuel Level 2	38	65276	0-100%	Fuel Level 2
Engine Fuel Delivery Pressure	94	65263	0-140 PSI	Fuel Pressure
Engine Injector Metering Rail 1 Pressure	157	65243	0-32767 PSI	Fuel Rail 1 Pr
Engine Fuel Rate	183	65266	0-40 GPH	Fuel Rate
Engine Fuel Temperature 1	174	65262	0-400 °F	Fuel Temp
High Resolution Total Vehicle Distance	917	65217	0-999999 Miles	HR Vehicle D
Hydraulic Retarder Oil Temperature	120	65275	0-400 °F	Hyd Rt Oil Tm
Hydraulic Retarder Pressure	119	65275	0-500 PSI	Hyd Rt Press
Hydraulic Oil Level	2602	65128	0-100 PSI	Hydr Oil Lvl
Hydraulic Temperature	1638	65128	0-400 °F	Hydraulic Temp
Cab Interior Temperature	170	65269	-100 - 150 °F	Inside Air Tm
Engine Intercooler Temperature	52	65262	0-400 °F	Intrcoolr Tmp
Latitude	584	65267	-180 - 180°	Latitude
Longitude	585	65267	-180 - 180°	Longitude
Engine Intake Manifold 1 Temperature	105	65270	0-400 °F	Manifold Temp
MIL Lamp	1213	N/A	0-1 (Off-On)	MIL Lamp
Navigation-Based Vehicle Speed	517	65256	0-200 MPH	NAV Speed
Ambient Air Temperature	171	65269	-100 - 200 °F	Outside Air Tm
Parking Brake Actuator	619	65274	0-1 (Off-On)	Park Brake Ac
Parking Brake Switch	70	65265	0-1 (Off-On)	Parking Brake
Engine Percent Load At Current Speed	92	61443	0-120%	Percent Load
Port Trim Tab	N/A (NMEA 2000 Marine)		0-100%	Port Tab
Protect Lamp	987	N/A	0-1 (Off-On)	Protect Lamp
Power Takeoff Oil Temperature	90	65264	0-400 °F	PTO Oil Temp
Power Takeoff Speed	186	65264	0-8000 RPM	PTO Speed
Red Stop Lamp	623	N/A	0-1 (Off-On)	Red Stop Lmp
Road Surface Temperature	79	65269	-100 - 500 °F	Road Temp
Sea Water Pump Outlet Pressure	2435	65172	0-72 PSI	Sea Water Prs
Wheel-Based Vehicle Speed	84	65265	0-200 MPH	Speed
Starboard Trim Tab	N/A (NMEA 2000 Marine)		0-100%	Starboard Tab
Steering Axle Temperature	75	65273	0-400 °F	Steer Axle T
Engine Throttle Position	51	65266	0-100%	Throttle
Tire Location	929	65268	0-255	Tire Location















• Vantage View® Implementation of SAE J1939 Parameters















Parameter Name	SPN	PGN	Range	LCD Display Name
Tire Pressure	241	65268	0-140 PSI	Tire Press
Tire Temperature	242	65268	-100 - 250 °F	Tire Temp
Transmission Oil Level	124	65272	0-100%	Trans Oil Lvl
Transmission Oil Pressure	127	65272	0-500 PSI	Trans Oil Prs
Transmission Oil Temperature	177	65272	0-500 °F	Trans Oil Tmp
Trip Average Fuel Rate	1029	65203	0-800 GPH	Trip Avg Fuel
Trip Drive Fuel Economy	1006	65209	0-200 MPG	Trip Fuel Eco
Engine Turbocharger 1 Speed	103	65245	0-250,000 RPM	Turbo 1 Speed
Engine Turbocharger Oil Temperature	176	65262	0-500 °F	Turbo Oil Tmp
Engine Turbocharger Lube Oil Pressure 1	104	65245	0-140 PSI	Turbo Oil
Total Vehicle Distance	245	65248	0-999999 Miles	Vehicle Dist
Total Vehicle Hours	246	65255	0-999999 Hours	Vehicle Hours
Engine Wait to Start Lamp	1081	65252	0-1 (Off-On)	Wait/Strt Lmp
Washer Fluid Level	80	65276	0-100%	Washer Level
Water In Fuel Indicator	97	65279	0-1 (Off-On)	Water in Fuel

Vantage View® Implementation of SmartCraft® Parameters	
Parameter Name	Parameter Name
Diesel MS Boost Pressure	Gas/Diesel LS Sea Water Temperature
Diesel MS Load Percent	Gas/Diesel MS Boat Speed (Paddle Wheel)
Gas MS Actual Gear	Gas/Diesel MS Engine RPM
Gas MS Fault: Water Pressure	Gas/Diesel MS Fault: CAN
Gas MS Manifold Pressure	Gas/Diesel MS Fault: Check Engine/Guardian
Gas MS Manifold Vacuum	Gas/Diesel MS Fault: Coolant Temperature
Gas MS Trim Position	Gas/Diesel MS Fault: Oil
Gas MS Warn: Guardian Active	Gas/Diesel MS Fault: Voltage
Gas MS Warn: Low Block Pressure	Gas/Diesel MS Fault: Water In Fuel
Gas MS Warn: Low Drive Lube	Gas/Diesel MS Fuel Flow Total
Gas MS Warn: Low Oil Remote	Gas/Diesel MS Fuel Pressure
Gas MS Warn: Low Oil Reserve	Gas/Diesel MS Steering Angle
Gas/Diesel LS Accumulated Break-in Time	Gas/Diesel MS Throttle Position
Gas/Diesel LS Airmar Data Status	Gas/Diesel MS Warn: Check Engine
Gas/Diesel LS Airmar Depth	Gas/Diesel MS Warn: High Voltage
Gas/Diesel LS Airmar Optional Temperature	Gas/Diesel MS Warn: Low Oil Pressure
Gas/Diesel LS Airmar Sea Water Temperature	Gas/Diesel MS Warn: Low Voltage
Gas/Diesel LS Barometric Pressure	Gas/Diesel MS Warn: Over Speed
Gas/Diesel LS Battery Voltage	Gas/Diesel MS Warn: Over-Heat
Gas/Diesel LS Block/Water Pressure	Gas/Diesel MS Warn: Water in Fuel
Gas/Diesel LS Boat Speed (Airmar Data)	Gas/MS Boat Speed (Low/High Press Pitot)
Gas/Diesel LS Break-in Time Required	
Gas/Diesel LS Coolant Temperature	
Gas/Diesel LS Engine Type	
Gas/Diesel LS Exhaust Temperature	
Gas/Diesel LS Fuel Level 1	
Gas/Diesel LS Fuel Level 2	
Gas/Diesel LS Gear Pressure	
Gas/Diesel LS Gear Temperature	
Gas/Diesel LS Intake Manifold Temperature	
Gas/Diesel LS Oil Level	
Gas/Diesel LS Oil Pressure	
Gas/Diesel LS Oil Temperature	
Gas/Diesel LS Oil Time & Complete	
Gas/Diesel LS Port Coolant Temperature	
Gas/Diesel LS Reserve Oil Remaining	
Gas/Diesel LS Run Time	















• SmartCraft® Engine Data Sensor List									
Data Item	2 Stroke Outboard	4 Stroke Outboard	Sterndrive No Troll	Inboard No Troll	JetDrive	SternDrive	Inboard	Make (Verado)	Diesel
Data Item									
Gear Pressure									X
Gear Temperature									X
Intake Manifold Temp									X
Oil Pressure			X	X		X	X	X	X
Oil Temperature			X	X		X	X	X	X
Coolant Temperature	X	X	X	X	X	X	X	X	X
Voltage	X	X	X	X	X	X	X	X	X
Block Pressure	X	X	X	X	X	X	X	X	
Engine Run Time	X	X	X	X	X	X	X	X	X
Engine Speed	X	X	X	X	X	X	X	X	X
Fuel Pressure			X	X		X	X	X	
Throttle Position									X
Load Percent									X
Actual Gear	X	X	X	X	X	X	X	X	X
Fuel Flow	X	X	X	X	X	X	X	X	X
Boost		X	X	X		X	X	X	X
Fuel Level 1	X	X	X	X	X	X	X	X	X
Tank Level 2		X	X	X	X	X	X	X	X
Oil Level	X								
AirMar1 Boat Speed	X	X	X	X	X	X	X	X	X
AirMar1 Depth	X	X	X	X	X	X	X	X	X
AirMar1 Seawater Temp	X	X	X	X	X	X	X	X	X
Pitot Speed	X	X	X	X		X	X	X	
Paddle Speed	X	X	X	X	X	X	X	X	
Trim Position	X	X	X			X		X	
Steering (Rudder) Angle			X	X		X	X		
Trim Tabs	X	X	X	X	X	X	X	X	















• Parameter Icons & Descriptions

Parameter Icon	Description
	Accelerator Pedal Position
	Alternator Current or Voltage
	Altitude
	Atmospheric/Barometric Pressure
	Air Temperature (Inside)
	Air Temperature (Outside)
	Average Fuel Economy
	Battery Voltage or current
	Black Water (Sewage) Level or Waste Water
	Block Pressure
	Boost Pressure
	Brake Application Pressure
	Brake Primary Pressure
	Engine Oil Pressure







Parameter Icon	Description
	Brake Secondary Pressure
	Compass Heading
	Crankcase Pressure
	Cruise Control Active
	Drive Axle Temperature
	Engine Coolant Level
	Engine Coolant Pressure
	Engine Coolant Temperature
	Engine Exhaust Temperature
	Engine Intercooler Temperature
	Engine Manifold Pressure
	Engine Manifold Temperature
	Engine Oil Level
	Hydraulic Oil Temperature









• Parameter Icons & Descriptions

Parameter Icon	Description
	Engine Oil Temperature
	Engine RPM/Speed
	Fresh Water Level
	Fuel Level
	Fuel Level 2
	Fuel Pressure
	Fuel Rate/Flow Total
	Fuel Temperature
	Gear Pressure
	Gear Temperature
	Hourmeter
	Hydraulic Oil Level
	Road Surface Temperature
	Rudder Angle









Parameter Icon	Description
	Hydraulic Retarder Oil Temperature
	Hydraulic Retarder Pressure
	Instantaneous Fuel Economy
	Latitude
	Live Well Level
	Longitude
	Percent Load
	Percent Engine Torque
	Parking Brake Switch or Actuator
	Power Takeoff Oil Pressure
	Power Takeoff Oil Temperature
	Power Takeoff Speed
	Transmission Gear/ Actual Gear/Current Gear
	Transmission Oil Level







• Parameter Icons & Descriptions

Parameter Icon	Description
SPEED	Speed, Wheel or Water Based
	Steering Angle
STR AXL 	Steering Axle Temperature
	Throttle Position
	Tire Pressure
	Tire Temperature
TRIM 	Tilt/Trim Position
	Total Engine Hours
Trip	Total Trip Distance
Total	Total Vehicle Distance
Trip MPG	Trip Drive Fuel Economy

Parameter Icon	Description
TRIP FUEL	Trip Fuel
	Transmission Oil Pressure
	Transmission Oil Temperature
	Turbocharger Oil Temperature
	Turbocharger Speed
	Water In Fuel
	Warning
	Washer Fluid Level
DEPTH	Water Depth
	Water Temperature

• Menu Navigation Icon Descriptions

Menu Navigation Icon	Description
	Menu List Identifier
	Selection Arrow Cursor
	Blinking Bar Cursor (Shown under number 0, zero)
	Fault Indicator (Blinks)
	Warning Indicator (Blinks)
	Alarm Indicator (Blinks)
	Higher Than Alarm Threshold Indicator
	Lower Than Alarm Threshold Indicator

Menu Navigation Icon	Description
	Analog to Digital Signal Source Identifier
	No CAN Data Present
	No CAN Data Present
	Indicates Analog Input 1
	Indicates Analog Input 2
	Indicates Analog Input 3
	Indicates Data is Read from Analog Slave Instru- ment

• Notes

• Notes



Livorsi Marine, Inc.
715 Center Street
Grayslake, IL 60030 USA
Toll Free: 877.548.5900
Office: 847.752.2700
Fax: 847.752.2415
Email: sales@livorsi.com
www.livorsi.com